



**INSTALLATION & INSTRUCTION
MANUAL
EVI DC INVERTER
AIR TO WATER HEAT PUMP**

V4.7

Aug 2024

Contents

Notice – Warnings	4
Specification	5
Technical Parameters of Arctic Air to Water Heat Pumps.....	5
COP CURVE	6
Heating Performance Table	6
Recommended Circulation Pump (External)	8
Heat Pump Flow Pressure Drop Curves.....	8
Installation	10
Heat Pump Installation	10
Accessing Additional Heat Pump Parts.....	12
Automatic Air Venting	13
Installation Space Requirements:	14
Buffer Tank Installation.....	14
Installation of Indoor Heating and Cooling Equipment	15
Water Pipe Connections.....	15
Note on Choosing Piping Sizes:	16
Installation of the Temperature Sensor	17
Electrical Wiring	17
Electrical Wire Selection – Warning.....	18
What Gets Connected and Where.....	18
Start Up.....	21
Single Tank versus Dual Tank	22
The Use of the Wired Controller	23
Buttons and Display Symbols Explanation.....	23
Wired Controller Operations	24
Keyboard Locking / Unlocking Operation	24
Turning the Unit ON/OFF.....	24
Modifying the Temperature Setting	24
Mode Select Operation	24
Forced Defrost	26
Clock Setting	26
Changing Between Celsius & Fahrenheit.....	26
Factory Reset	26
Timer ON/OFF Settings.....	26
Cancelling Timer Operation	26
Timer Programming	27
Force the Backup to Run.....	28
Selecting Energy Saving Mode, Quiet Running Mode, and Fast Heating Mode.....	28
Checking of State Parameters	28

Maintenance and Repair	29
Antifreeze Protection for Cold Climates	29
Error Code Table	30
Wiring Diagrams	32
Controller Board	32
Wiring Diagram Single Tank - Basic.....	34
Wiring Diagram Single Tank – HBX	35
Overview	35
Wiring Diagram Dual Tank – Basic.....	37
Wiring Diagram Dual Tank – HBX.....	38
Intelligent Defrost	39
Enter Defrost Mode	39
Exit Defrost Mode	39
Mild Climate Defrost	39
Back Up Heating	40
Turn On	40
Turn Off.....	40
Back Up Heater	41
AltSource Integration.....	42
External Boiler Integration.....	42
HBX Advanced Back Up ECO-0600.....	44
Domestic Hot Water	46
3-Way Valves	48
Multiple Heat Pumps	49
Wiring Cn31 in series for Dual Heat Pumps.....	51
Heating and Cooling - BASIC	52
Heating and Cooling – Advanced	53
ECO-0600 Heating Cooling Reset.....	54
Warranty.....	56

Notice – Warnings

To use this product better and more safely, please read this manual carefully before installation and initial operation. Save this manual for future reference.

This heat pump must be installed by qualified and experienced technicians/trade-persons. Improper Installation of this heat pump may cause damage and danger.

This heat pump must be installed in accordance with local wiring regulations including an isolating switch from the supply mains and grounded power supply consistent with the power specification of this heat pump.

The installation of this heat pump must comply with the model's wiring chart in this manual, and its power requirements as stated on the rating label on the side of the heat pump.





Do not install this heat pump close to flammable or explosive materials, or open flames.

Checking and cleaning of the evaporator fin coil regularly is recommended for good and efficient air flow.



Specification

Technical Parameters of Arctic Air to Water Heat Pumps

					
Model		ARCTIC	035ZA/(BE)	050ZA/(BE)	060ZA/(BE)
Power Supply		V/P/Hz	220~240/1/60	220~240/1/60	220~240/1/60
Rated Cooling Capacity	Ambient Temp 35°C Water Outlet 7°C	kW	7.1	10.5	12.2
Cooling Power Input		kW	2.90	4.16	4.97
Cooling Current Input		A	13.2	18.9	22.6
Co-Efficiency of Performance		COP	2.4	2.5	2.5
Rated Heating Capacity	Ambient Temp 7°C Water Outlet 45°C	kW	8.3	14.0	17.0
Heating Power Input		kW	2.72	4.40	5.40
Heating Current Input		A	12.4	20.0	24.5
Co-Efficiency of Performance		COP	3.3	3.2	3.1
Rated Heating Capacity	Ambient Temp -7°C Water Outlet 45°C	kW	7.0	11.5	13.5
Heating Power Input		kW	2.21	3.68	4.34
Heating Current Input		A	10.0	16.7	19.7
Co-Efficiency of Performance		COP	3.2	3.1	3.1
Rated Heating Capacity	Ambient Temp -20°C Water Outlet 45°C	kW	5.5	8.3	9.7
Heating Power Input		kW	3.18	4.68	5.58
Heating Current Input		A	14.5	21.3	25.4
Co-Efficiency of Performance		COP	1.7	1.8	1.7
Total Load		A	17.40	27.60	27.60
Breaker Sizing		A	30.0	40.0	40.0
Nominal Water Flow Volume		GPM	6.50	11.00	13.00
Water Pressure Drop		psi/Ft head	4.77/11	6.37/14.7	11/25.4
Water Inlet/Outlet (External Threaded)		inch	1"	1"	1"
Refrigerant			R410A	R410A	R410A
Refrigerant Amount		OZ	70.5	105.8	105.8
Sound Level		dB(A)	53	54	55
IP Rating			IPX4	IPX4	IPX4
Net Weight		KG/LBS	92/203	128/282	131/289
Unit Dimensions(L/W/H)		mm	1145/470/883	1000/440/1380	1000/440/1380
Unit Dimensions(L/W/H)		inches	45.07"/18.50"/34.76"	39.37"/17.32"/54.33"	39.37"/17.32"/54.33"
Certification					

Refrigerant Amounts

For older units check the nameplate for the required amount of refrigerant.

MODEL	035ZA/(BE)	050ZA/(BE)	060ZA/(BE)
R410A	70.5 OZ	105.8 OZ	105.8 OZ

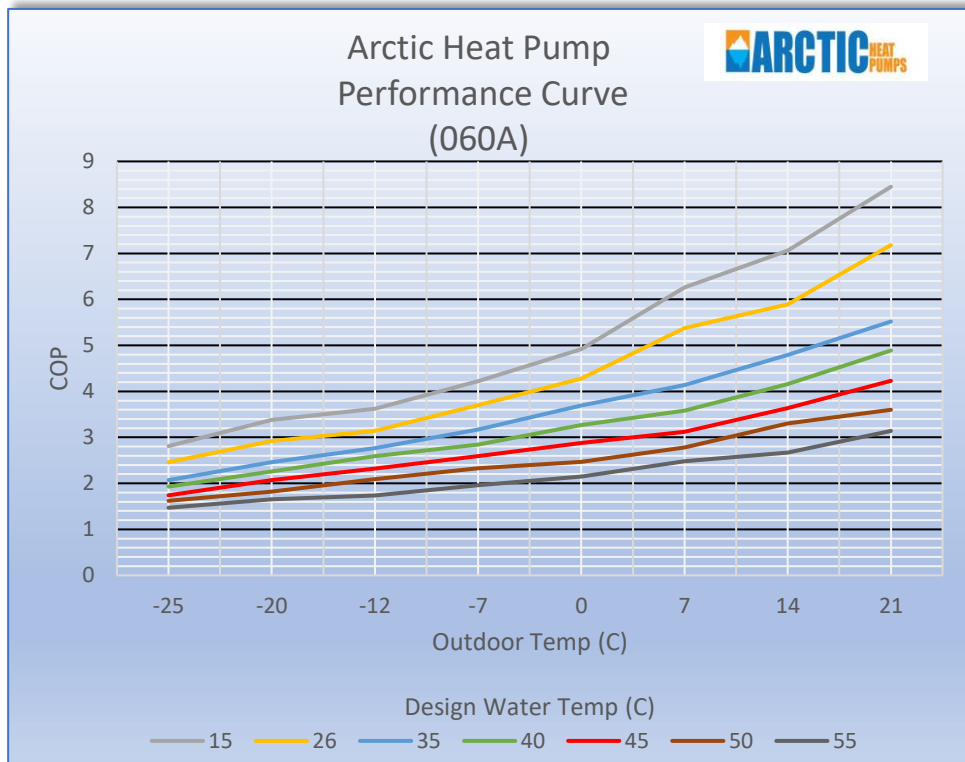

COP CURVE

Heating Performance Table



EVI DC inverter heat pump		Ambient temperature (°C)												
ARCTIC 035ZA/(BE)		-30	-25	-20	-15	-12	-7	2	7	15	21	30	38	
 outlet water temperature (°C)	20	heating capacity (W)	4015	4401	5456	5873	6092	7100	8173	9142	11205	12077	13212	14324
		power input (W)	1859	1913	1956	1882	1638	1663	1699	1677	1779	1538	1332	1155
		COP (W/W)	2.16	2.30	2.79	3.12	3.72	4.27	4.81	5.45	6.30	7.85	9.92	12.40
	30	heating capacity (W)	3912	4324	5413	5866	6072	7092	8165	9099	11193	12065	13192	14300
		power input (W)	2048	2130	2183	2088	1834	1917	1899	1876	2061	1741	1527	1387
		COP (W/W)	1.91	2.03	2.48	2.81	3.31	3.70	4.30	4.85	5.43	6.93	8.64	10.31
	35	heating capacity (W)	3876	4291	5399	5852	6068	7088	8145	9085	11182	12048	13175	14285
		power input (W)	2307	2411	2488	2251	2057	2215	2244	2163	2349	2035	1745	1620
		COP (W/W)	1.68	1.78	2.17	2.60	2.95	3.20	3.63	4.20	4.76	5.92	7.55	8.82
	41	heating capacity (W)	3837	4276	5364	5832	6057	7083	8133	9068	11168	12035	13158	14265
		power input (W)	2460	2592	2669	2514	2303	2409	2480	2484	2691	2184	1979	1838
		COP (W/W)	1.56	1.65	2.01	2.32	2.63	2.94	3.28	3.65	4.15	5.51	6.65	7.76
	45	heating capacity (W)	3765	4213	5506	5821	6044	6958	8129	8306	11157	12027	13138	14154
		power input (W)	2597	2650	3183	2622	2437	2424	2746	2723	2846	2358	2190	2097
		COP (W/W)	1.45	1.59	1.73	2.22	2.48	2.87	2.96	3.05	3.92	5.10	6.00	6.75
	50	heating capacity (W)	3728	4146	5195	5010	6028	7042	8110	9028	11132	12019	13017	14166
		power input (W)	2761	2820	3309	2493	2728	2657	2856	3019	3025	2530	2494	2393
		COP (W/W)	1.35	1.47	1.57	2.01	2.21	2.65	2.84	2.99	3.68	4.75	5.22	5.92
	55	heating capacity (W)		4123	5354	5001	6005	7021	8100	9007	11121	12002	12901	14037
		power input (W)		3352	4056	2689	2873	2913	3057	3205	3177	2824	2792	2689
		COP (W/W)		1.23	1.32	1.86	2.09	2.41	2.65	2.81	3.50	4.25	4.62	5.22
	60	heating capacity (W)				4968	5966	7010	8072	8955	11108	11977	12876	13946
		power input (W)				2855	3059	3143	3178	3256	3316	2994	2960	2858
		COP (W/W)				1.74	1.95	2.23	2.54	2.75	3.35	4.00	4.35	4.88



EVI DC inverter heat pump		Ambient temperature (°C)												
ARCTIC 050ZA/(BE)		-30	-25	-20	-15	-12	-7	2	7	15	21	30	38	
 outlet water temperature (°C)	20	heating capacity (W)	6788	7325	9889	10102	10349	11800	13850	15625	17388	19783	23556	24453
		power input (W)	3114	3241	3544	3238	2797	2810	2856	2862	2760	2520	2370	1985
		COP (W/W)	2.18	2.26	2.79	3.12	3.70	4.20	4.85	5.46	6.30	7.85	9.94	12.32
	30	heating capacity (W)	6526	7288	9842	10046	10324	11750	13774	15376	17305	19712	23123	24256
		power input (W)	3417	3644	3969	3575	3119	3176	3203	3237	3187	2844	2676	2353
		COP (W/W)	1.91	2.00	2.48	2.81	3.31	3.70	4.30	4.75	5.43	6.93	8.64	10.31
	35	heating capacity (W)	6325	7200	9700	9950	10288	11650	13628	15290	17259	19688	22856	23995
		power input (W)	3765	4045	4450	3827	3511	3641	3754	3702	3626	3326	2968	2721
		COP (W/W)	1.68	1.78	2.18	2.60	2.93	3.20	3.63	4.13	4.76	5.92	7.70	8.82
	41	heating capacity (W)	6223	7121	9601	9785	10178	11623	13548	15202	17216	19602	22246	23586
		power input (W)	3989	4316	4730	4200	3870	3994	4130	4307	4148	3558	3305	3039
		COP (W/W)	1.56	1.65	2.03	2.33	2.63	2.91	3.28	3.53	4.15	5.51	6.73	7.76
	45	heating capacity (W)	6180	7002	8291	9627	10102	11467	13495	14139	17182	19589	22103	22789
		power input (W)	4262	4404	4684	4336	4073	4024	4410	4446	4383	3841	3672	3401
		COP (W/W)	1.45	1.59	1.77	2.22	2.48	2.85	3.06	3.18	3.92	5.10	6.02	6.70
	50	heating capacity (W)	6036	6922	9324	9451	10002	11495	13388	15011	17095	19518	21036	22068
		power input (W)	4471	4709	5939	4679	4526	4562	4617	4890	4645	4109	4030	3885
		COP (W/W)	1.35	1.47	1.57	2.02	2.21	2.52	2.90	3.07	3.68	4.75	5.22	5.68
	55	heating capacity (W)		6744	9178	9227	9945	11376	13185	14875	17001	19466	20002	21312
		power input (W)		5483	6556	4934	4781	4862	4901	5025	4857	4580	4455	4332
		COP (W/W)		1.23	1.40	1.87	2.08	2.34	2.69	2.96	3.50	4.25	4.49	4.92
	60	heating capacity (W)				9008	9723	11124	12920	14537	16950	19402	19588	20156
		power input (W)				5237	5012	5056	5087	5173	5060	4851	4697	4509
		COP (W/W)				1.72	1.94	2.20	2.54	2.81	3.35	4.00	4.17	4.47



EVI DC inverter heat pump		Ambient temperature (°C)												
ARCTIC 060ZA/(BE)		-30	-25	-20	-15	-12	-7	2	7	15	21	30	38	
 outlet water temperature (°C)	20	heating capacity (W)	8432	9212	11569	12235	12588	13955	15862	18427	20415	22068	24326	25121
		power input (W)	3924	4079	4107	3990	3688	3722	3811	3952	3302	2821	2453	2026
		COP (W/W)	2.15	2.26	2.82	3.07	3.41	3.75	4.16	4.66	6.18	7.82	9.92	12.40
	30	heating capacity (W)	8092	9002	11439	12125	12375	13903	15789	18388	20202	21862	24127	24688
		power input (W)	4252	4452	4524	4215	4046	4121	3998	4172	3725	3165	2799	2339
		COP (W/W)	1.90	2.02	2.53	2.88	3.06	3.37	3.95	4.41	5.42	6.91	8.62	10.55
	35	heating capacity (W)	7928	8907	11173	12081	12217	13898	15690	18220	20052	21661	24102	24322
		power input (W)	4762	5002	5070	4620	4402	4480	4423	4556	4233	3658	3126	2759
		COP (W/W)	1.66	1.78	2.20	2.61	2.78	3.10	3.55	4.00	4.74	5.92	7.71	8.82
	41	heating capacity (W)	7823	8550	10702	11822	12184	13715	15611	18102	19825	21465	24080	24124
		power input (W)	4985	5180	5307	4852	4694	4715	4777	5370	4811	3896	3589	3125
		COP (W/W)	1.57	1.65	2.02	2.44	2.60	2.91	3.27	3.37	4.12	5.51	6.71	7.72
	45	heating capacity (W)	7628	8766	9705	11600	12080	13525	15421	17044	19733	21321	24002	23124
		power input (W)	5212	5499	5579	5160	4896	4342	4923	5413	5066	4102	3956	3445
		COP (W/W)	1.46	1.59	1.74	2.25	2.47	3.11	3.13	3.15	3.90	5.20	6.07	6.71
	50	heating capacity (W)	7412	8512	10542	11352	11901	13490	15376	17960	19320	21280	20861	21023
		power input (W)	5465	5796	6610	5782	5656	5160	5399	5983	5284	4522	4033	3712
		COP (W/W)	1.36	1.47	1.59	1.96	2.10	2.61	2.85	3.00	3.66	4.71	5.17	5.66
	55	heating capacity (W)		8058	9178	11220	11830	13188	15120	17700	19102	21121	18812	19562
		power input (W)		6485	6556	5940	5936	5643	5905	6072	5466	5021	4218	3989
		COP (W/W)		1.24	1.40	1.89	1.99	2.34	2.56	2.92	3.49	4.21	4.46	4.90
	60	heating capacity (W)				11123	11642	12731	14810	17500	18872	21022	18312	18601
		power input (W)				6210	6184	5854	6098	6232	5712	5412	4424	4312
		COP (W/W)				1.79	1.88	2.17	2.43	2.81	3.30	3.88	4.14	4.31

Recommended Circulation Pump (External)

Technical Specifications

UPS26-99FC (240 VAC):

- Voltage: 230vac
- Amperage at Speed 1: 1.3 Amps.
- Amperage at Speed 2: 1.5 Amps.
- Amperage at Speed 3: 1.8 Amps.
- Hertz: 60 Hz.
- Phase: 1.
- Watts at Speed 1: 150W.
- Watts at Speed 2: 179W.
- Watts at Speed 3: 197W.
- Max Pressure: 145 psi.
- Max Temperature: 230F.
- Min Temperature: 36F.
- Flow Range: 0-33 GPM.
- Head Range: 0-29 ft.
- Horsepower: 1/6HP.
- Body: Cast Iron.
- Connections: Flanged, 1/2", 3/4", 1", 1-1/4".

Grundfos UPS26-99FC Circulating Pump

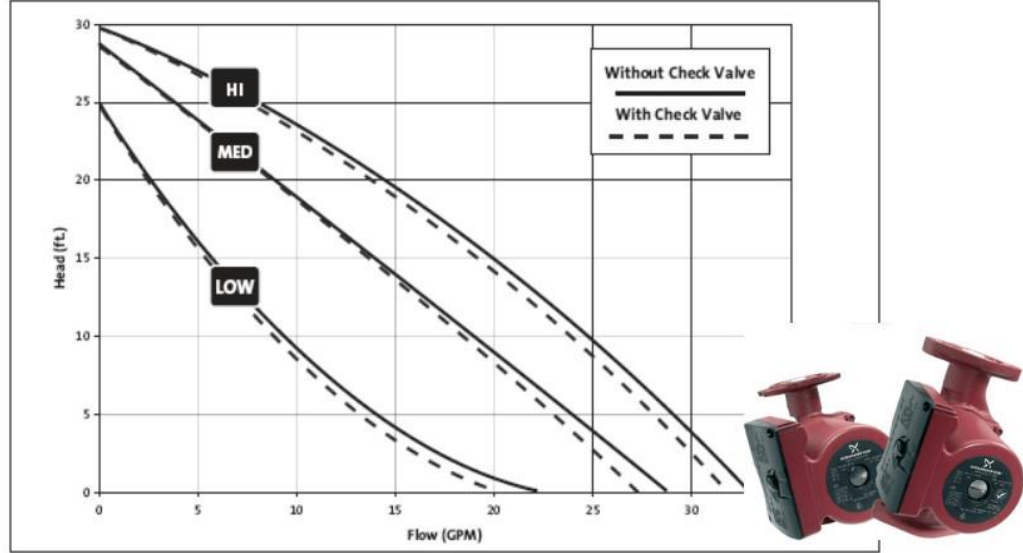

Heat Pump Flow Pressure Drop Curves

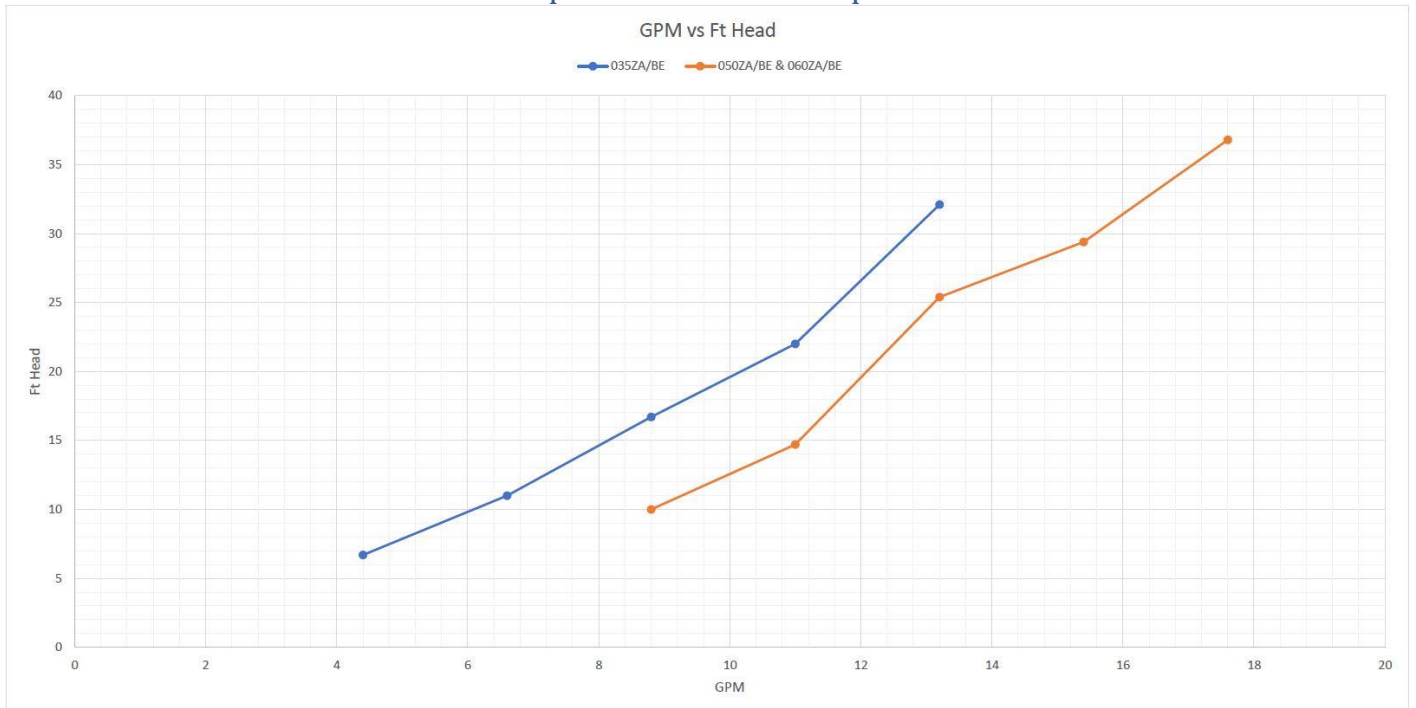

Product Dimensions

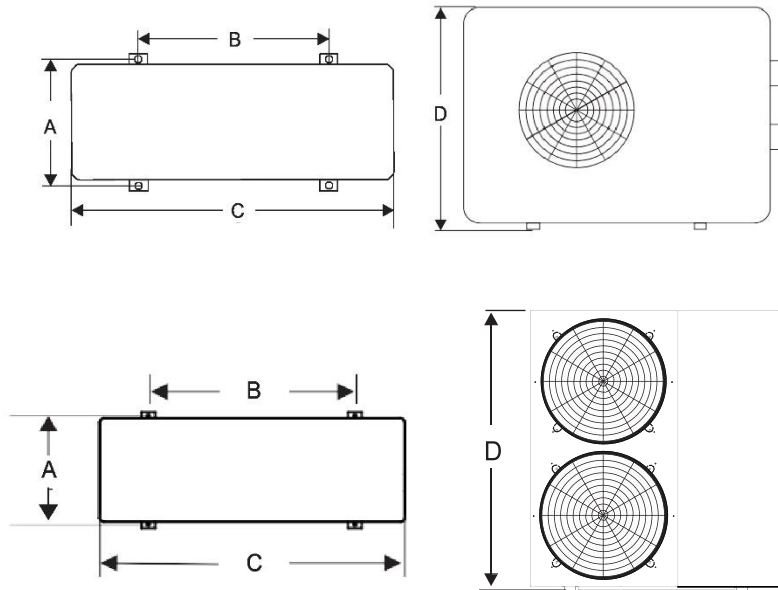

mm/inches

Size	035ZA/(BE)
A	440mm/17.3"
B	760mm/29.9"
C	1145mm/45"
D	883mm/34.8"

Size	050ZA/(BE) & 060ZA/(BE)
A	420mm/16.5"
B	700mm/27.6"
C	1000mm/39.4"
D	1380mm/54.3"

Size	070ZA/(BE)
A	440mm/17.3"
B	760mm/29.9"
C	1195mm/47"
D	1365mm/53.7"

Water Port Locations

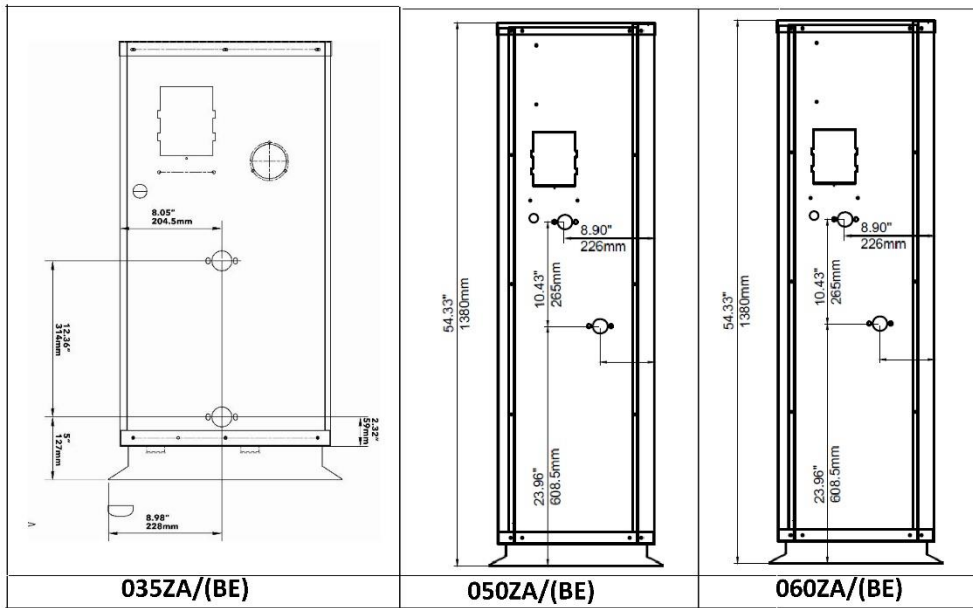

035ZA/(BE)

050ZA/(BE)

060ZA/(BE)

Installation

Heat Pump Installation

This heat pump requires good air flow through the fin coils for maximum efficiency. Also, hotter outside air temperature in cooling mode and colder outside air temperature in heating mode will reduce performance of the heat pump. Therefore, the hot/cold discharged air in cooling/heating modes from the heat pump should not be allowed to deflect back to the air inlet.

Please keep enough space around the heat pump for repairs and maintenance.

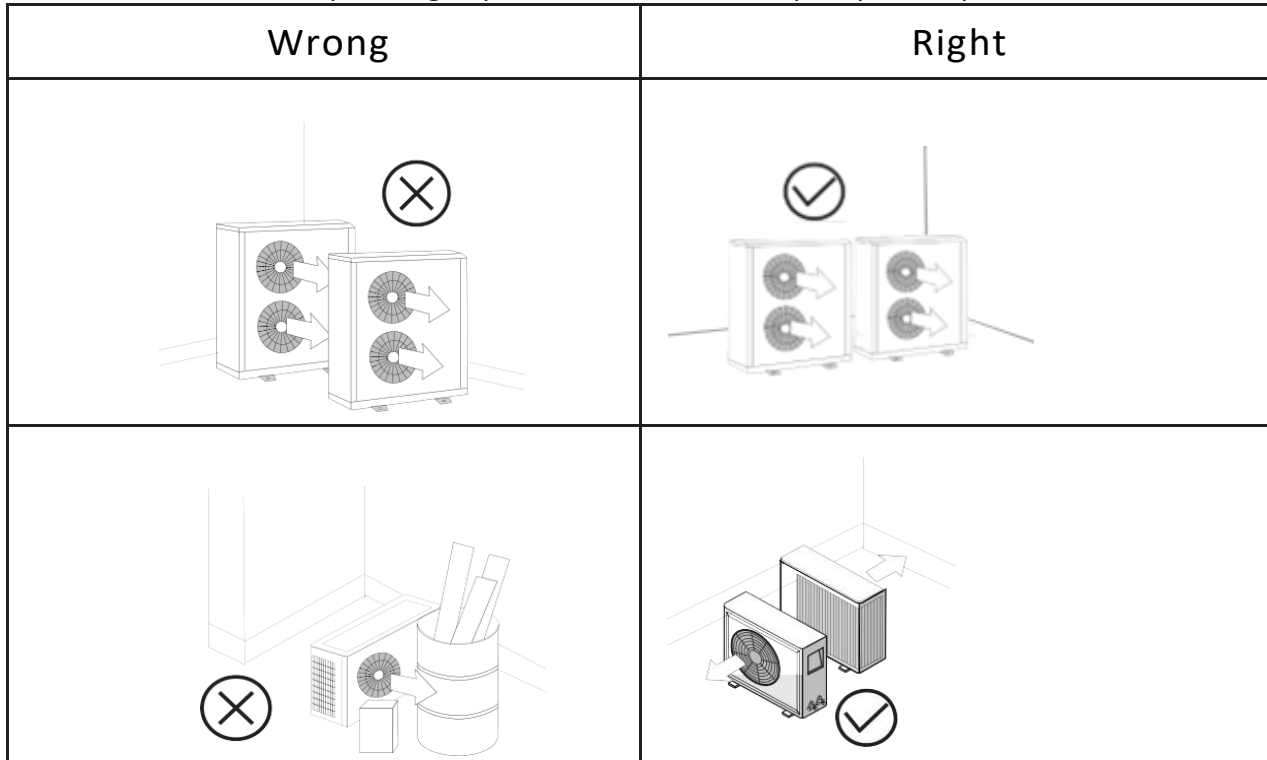

Installation Considerations:

- The installation position should have **good ventilation**.
- The installed heat pump **should not make extraneous noises** or rattling sounds.
- Try to **minimize direct sunlight** onto the unit.
- Water from rain or defrost mode will be discharged through a drain hole in the base plate. So, **the unit must be raised** in freezing climates to avoid ice buildup.
- The outlet air position **should not face a prevailing wind** direction, or this will reduce performance efficiency.
- Try to position the heat pump so the **outlet air does not discharge directly onto a fence or towards a neighbor**.
- The installation position should **not be located next to flammable materials, explosive materials, or open flames**.
- The heat pump should be **protected from oil** (such as engine oil in a factory environment), **salt** (such as sea spray or salty air) and/**or sulfides** (that may be present in the air from industrial activity or a thermal spring).
- The heat pump should ideally be installed on a **raised stand**, preferably secured to a concrete pad. Alternately, the heat pump can be installed on a balcony, ledge, wall, or roof provided there is a suitable load-bearing platform in place capable of supporting the weight of the unit and not transmitting vibration noise.
- There should be a **drainpipe** or channel from the heat pump to take the condensate water away from the unit.
- Do not install the control panel in a wet environment which may cause the control panel to malfunction.
- **In cold regions where the heat pump will be used primarily for heating, the unit needs to be raised off the ground 18-24" to allow ice accumulation below the drain hole, otherwise drain pan will become plugged.**



Elevate Heat Pump in Freezing Climate



Drain hole.

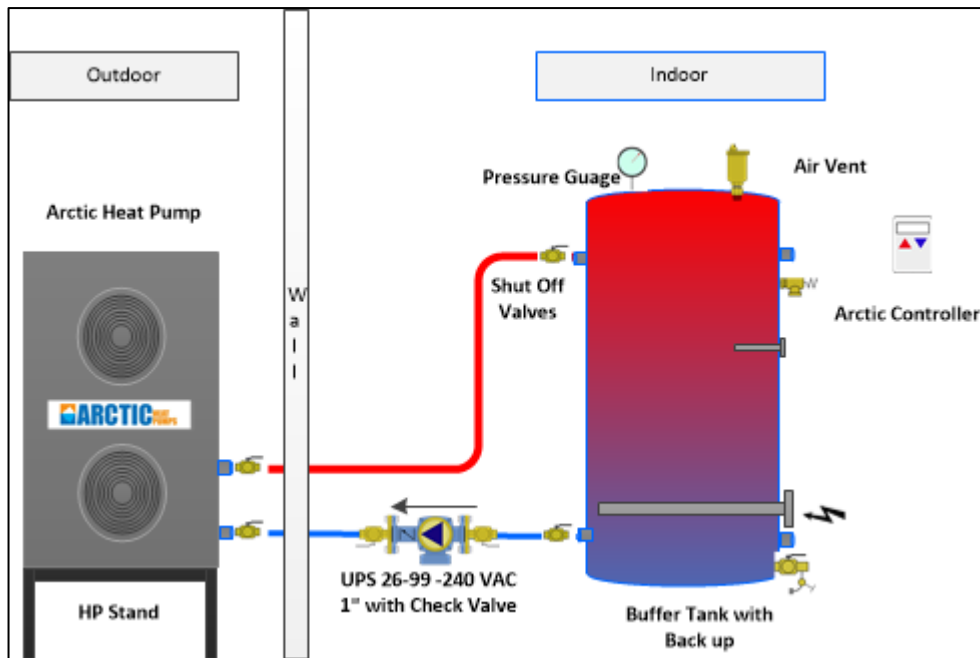

Basic Layout

Accessing Additional Heat Pump Parts

In addition to the heat pump, you will get 4 rubber anti-vibration pads for the unit to sit on as well as 2 brass thread adapters to convert the threads to NPT. There will also be spare screws for holding the body panels in place. Remove the main door located next to the fans (see below) and the parts will be located inside the unit next to the compressor. There will also be 2 washers for use with the brass thread adaptors and a 2-wire connector for use with Cn31. These will be in the bag with the manual found on top of the heat pump.

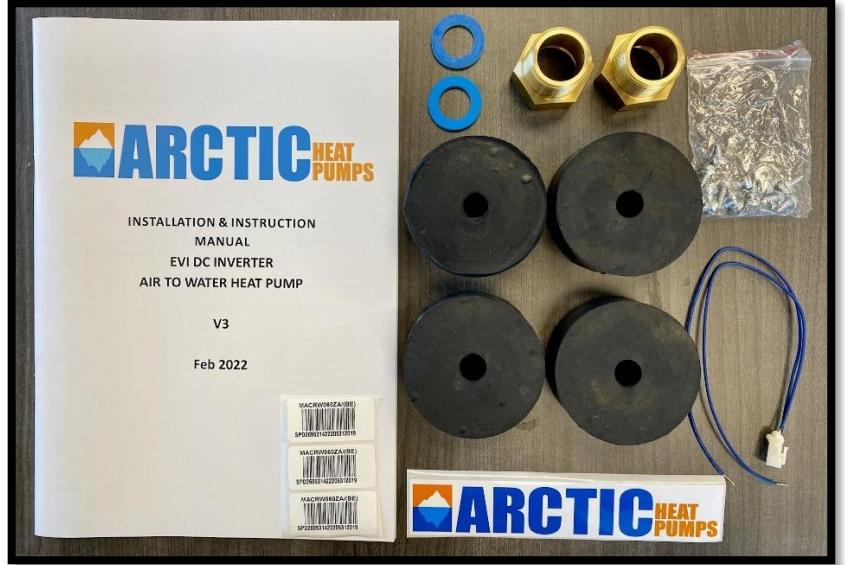

Automatic Air Venting

Automatic air vents should be installed on the system at all possible locations of an air lock. This is typically on top of the tank, on the outlet line of the heat pump, and at the highest point of the system. Most in-floor hydronic manifolds also have air vents built into them.

There are many brands of automatic air vents, but they all accomplish the same task of removing air from the system. It is good practice to install shut off valves for all air vents should they need to be closed off or replaced.

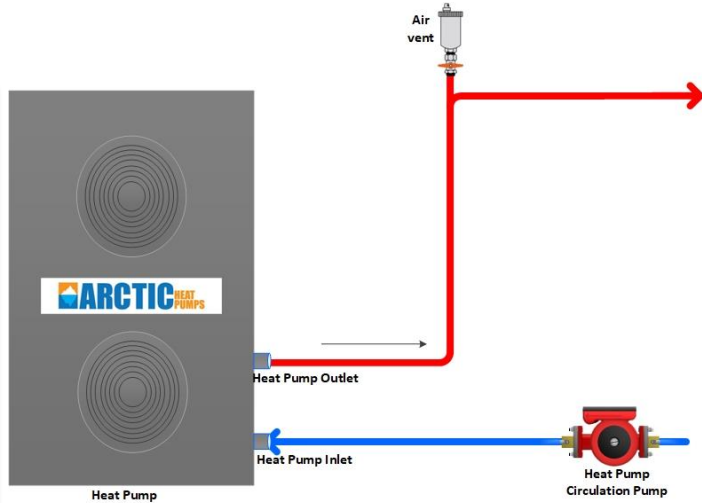

Typical air vent installation with insulation and shut off valve on the outlet line of the heat pump.



Caleffi 1/2" air vent and Ivar manifold with built in air vent.

Installation Space Requirements:

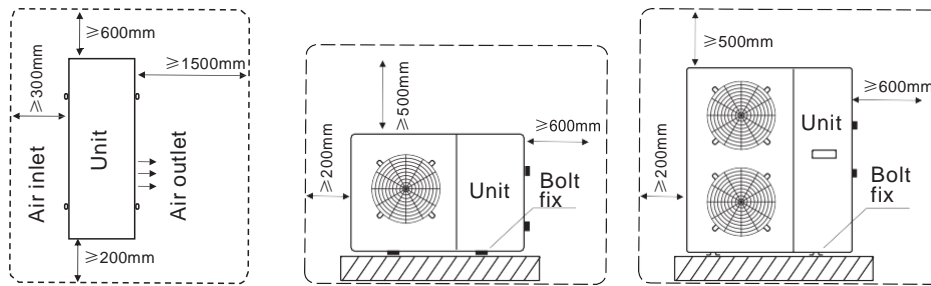

Buffer Tank Installation

Site Selection

- The Buffer tank should be **installed indoors and as close to the heat pump as possible**.
- When there is a chance of freezing, **glycol/water mixture** should be used in the buffer tank.
- The buffer tanks should be **installed on a concrete pad** and comply with local codes, so the tanks remain upright and stable.
- Some building codes require seismic restraint. **Consider restraining the buffer tanks** with stainless steel bands.
- Ensure the specification label is visible.
- A pressure limiting valve (**pressure release valve**) must be fitted with buffer tanks, consult local building codes.
- A **pressure and temperature relief valve** must be supplied with the domestic hot water tank, consult local building codes.
- A tempering (mixing) valve for hot water supply to bathrooms may be required by some local codes.
- A **drain** must be included to allow full and complete draining of the tank.
- It is recommended that the hot water outlet pipes **are fully insulated with weatherproof insulation** such as Armaflex or equivalent, to prevent heat loss externally.
- The hot water outlet pipes should be **angled down by 15 degrees minimum** for the first 250mm (10 inches) after exiting from the hot water storage or buffer tanks. This will create a heat trap that will avoid any thermal siphoning from the tanks.
- Fill the storage and buffer tanks by opening the pressure release or air release valve on top of the tank to **release buildup of air pressure in the tank** as fluid volume enters. Check all pipes for any signs of leaks. Power should not be turned on until the tanks are filled completely with water.

Installation of Indoor Heating and Cooling Equipment

- Indoor heating and cooling equipment such as fan coils, radiator heating or floor heating, should be **installed in accordance with relevant regulatory requirements**, engineering design drawings, and the manufacturer's installation instructions.
- Use **flexible piping** to connect the heat pump and indoor heating and cooling equipment, such as PEX or flexible stainless steel or flexible copper.
- If using fan coils to cool be sure to **install condensate water drainpipes** to the indoor fan coil units with smooth drainage lines for the condensate water to flow easily.

Water Pipe Connections

- Water pipe material should be heat resistant and rust-proof. This can be stainless steel, copper, aluminum, hot water PEX pipes, etc., according to local standards.
- The pipework of the system should follow the relevant standards, and transition to match the connection size of the heat pump.
- The hot water storage and buffer tank drain port and pressure and temperature relief valve should be installed to allow for proper drainage according to relevant standards.
- The pump is installed **INDOORS** located on the water inlet line (lower line) **with arrow on pump flowing to the heat pump.** Be sure to add an **isolation shut off valves** to service pump in the future.
- The hot water storage and buffer tank must be installed with an isolating valve to allow for maintenance.
- The water pipes should be arranged with minimal bends to reduce pressure loss in the system.
- The water inlet must be fitted with a **one-way check valve** (found in the UPC 26-99fc pump) and isolating valves for service.
- After all the pipes are connected, the system should be tested at water supply pressure for 24 hours to ensure that the system does not leak. Then insulate relevant hot and cold-water pipes, and their plumbing fittings.
- To discharge all air from the water pipeline, the water supply return pipe should have an automatic air bleeding valve installed at the highest point.
- An **expansion tank must be installed** into the system to absorb expansion of the closed loop as temperature increases in the system. It should be installed on the suction side of the pump.
- It is recommended to install, in the water flow and return, a thermometer and water pressure gauge to enable monitoring of key operational parameters.

Note:

1. The recommended pressure of the heat pump loop should be **11-20 psi**.
2. The water pipes should be **subjected to a pressure test** of twice the operating pressure before operation of the heat pump.
3. A **drainage pipe** should be installed to drain from the pressure/temperature relief valve.
4. The pressure/temperature relief valve should be **periodically exercised** by gently pulling the lever up. This will help to remove possible accumulation of calcium carbonate and ensure that the valve is working properly.
5. **Install** one-way (check) valves, shut off valves, pressure/temperature relief valves, and any other plumbing fittings consistently with the marked flow direction and in **accordance with relevant local standards**.

Note on Choosing Piping Sizes:

These notes are based on Type L copper pipe to ASTM Standards & VIPERT™ piping to ASTM standards.

- **The flow velocities are too high to use 1" Pex for the heat pump loop. Stick to 1" copper or 1.25" Pex pipe.**
- 1" Copper piping should be used unless the head pressures exceed the limit of the circ pump in which case the piping should be upsized to **1.25"**.
- If the piping distance between the heat pump and buffer tank **exceeds 90ft** (there and back) you should upsize from **1" copper to 1.25"**.
- For Pex pipe the head pressures are higher. You should only use **1.25" Pex** which is good up to about **120ft of pipe** at 11 gpm.
- If your system comprises of more than one heat pump you should always upsize to 1.25" piping and if the runs are quite long should go to 1.5" piping. If installing more than 2 heat pumps (3 or 4) a 2" header should be utilized.
- Remember to take into account any **3-way valve head pressures** when choosing piping sizes. The valves CV can be used to determine the head loss through the valve.

Flow Rate USgpm	Ft of Head / 100 feet of Copper pipe				
	½"	¾"	1"	1.25"	1.5"
0.80	1.69				
1.00	2.47				
1.50	4.97				
2.00	8.19	1.39			
2.50	12.10	2.04			
3.00		2.81			
3.50		3.67	1.06		
4.00		4.64	1.34		
4.50		5.70	1.65		
5.00		6.86	1.98		
5.50		8.11	2.34		
6.00		9.46	2.73	1.00	
6.50		10.89	3.14	1.16	
7.00		12.42	3.58	1.32	
7.50			4.04	1.48	
8.00			4.53	1.66	
8.50			5.04	1.85	
9.00			5.57	2.05	
9.50			6.13	2.25	0.98
10.00			6.71	2.46	10.8
10.50			7.32	2.68	1.17
11.00			7.95	2.92	1.27
11.50			8.60	3.15	1.38
12.00			9.27	3.40	1.49
13.00				3.01	1.71
14.00				4.46	1.95

Installation of the Temperature Sensor

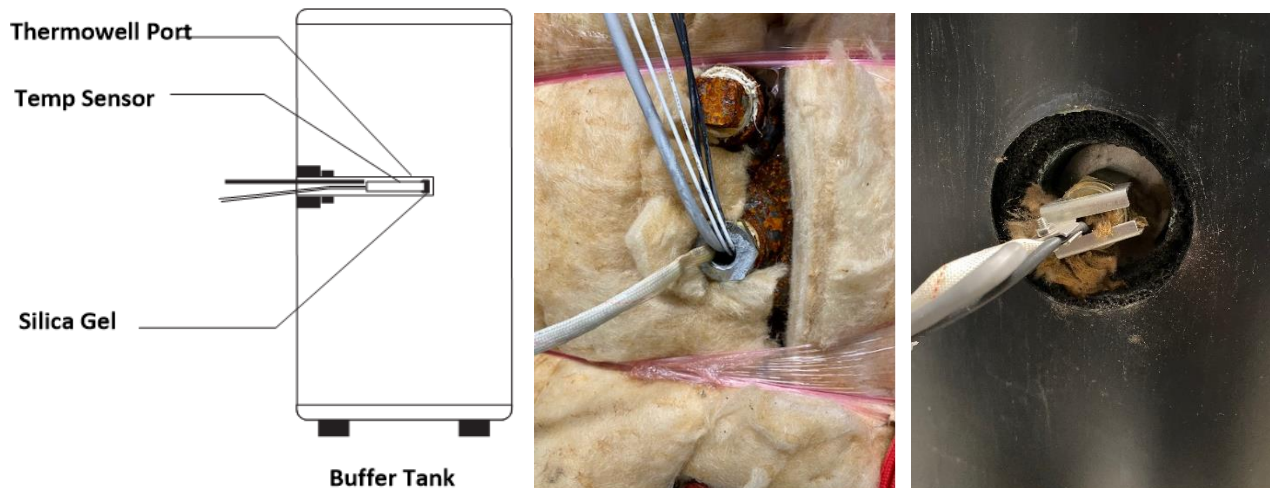

1. Firstly, place a small amount of heat conductive silicone onto the front of the temperature sensor, then insert it into the temperature thermowell port.
2. Next, push the temperature sensor through to the end of the thermowell, then mark the depth of the pin on the sensor wire.
3. Next, pull the sensor and check that the position of mark is at the same depth as the end of the sensor well to ensure the sensor is inserted into the sensor well all the way (use a thin wire to check depth of sensor well)
4. Finally, seal the inlet of the temperature detector with silicone.
5. Some systems use more than one sensor in a single well. We usually stick the ECO-0600 sensor into the well the deepest, then the heat pump sensor in behind the HBX sensor and then the sensor that came with the tank that we pulled out of the well goes behind the tanks insulation to give a general reading for the AltSource's display screen.

Electrical Wiring

- The heat pump should use a dedicated power cable with voltage and current capacity following electrical code given the voltage and amperage rating of the heat pump and circulating pump.
- Outdoor rated disconnect must be installed near the heat pump as per local codes.
- The power cable for the heat pump must be outdoor rated and protected in a metal jacket or conduit.
- The heat pump power supply circuit must have a grounding wire, which should connect with a reliable and effective external ground wire.
- Wiring must be installed by a qualified electrician with reference to the circuit diagram.
- The layout of power wires/cables and control cables should be neat, well supported and with power and control cables separated so they cannot interfere with each other.
- When power lines and control cables are parallel, the wires must be placed inside conduit, with appropriate distance between the cables.
- For electrical connection of the heat pump, pull the following wiring through the wiring hole of the electrical box, then connect to the appropriate terminals in the electrical box according to wiring diagram:
 - Power cable (240 VAC)
 - Digital Controller cable
 - Electric back up heater switch control cable
 - Temperature tank sensor cable
 - Pump cable (240VAC)
 - Optional 3-way Valve cable (240 VAC)

Electrical Wire Selection – Warning

- The internal compressor motor insulation does not protect the compressor against all possible conditions. Please be sure that the system is properly grounded when installed in the field.
- To avoid fire, electric shock, and other accidents, only use the power supply voltage indicated on the label.
- To protect the power cables, they should be secured appropriately so that they cannot become damaged, and people cannot trip over them. Outdoor rated wire should be used from the disconnect to the heat pump.
- Dedicated circuits should be used to avoid overloading breakers from other appliances.
- Check to ensure your electrical cable and fuse rating is appropriate for the power load and is properly grounded.

Specification Table of Power Code (single unit)

Mode	Power	Amps	Fuse	Wire size
035ZA	208~240V/1PH/60Hz	17.4	30 Amps	10 AWG
050ZA		27.6	40 Amps	8 AWG
060ZA		27.6	40 Amps	8 AWG

What Gets Connected and Where

Electrical wiring should be performed by a qualified electrician. There are 5-6 required connections that will need to be connected indoors. A hole should be drilled where the wires will transition through the wall.

- Main Supply Power – 240 VAC – **Must have an outdoor disconnect.**
- Pump Output Power – 240 VAC AWG #14 or 120 vac AWG #14 (Neutral Required)
- Control Panel (mount indoors) (4 control wires)
- Hot Water Tank Sensor (2 control wires)
- Back Up Heat Control (dry contact) (2 control wires)
- Optional 3 – Way Valve Output for Cooling -240 VAC AWG #14



Remove Power Access Panel



Connect Main & Pump Power



Remove front panel to access accessory terminal block

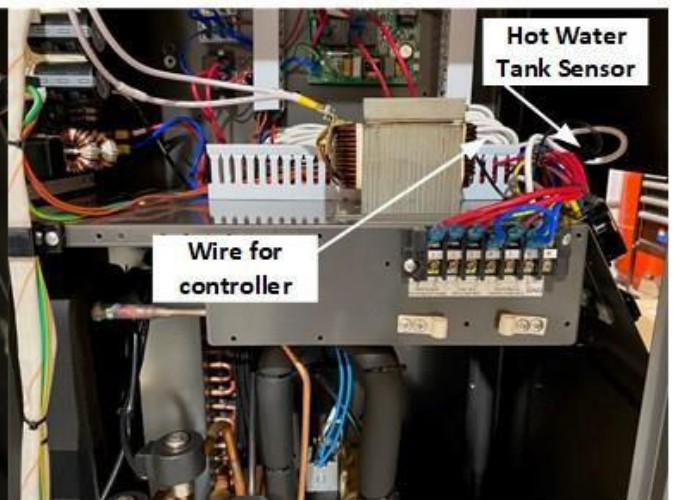

Remove wiring for controller & hot water tank sensor

1 + 2	dry contact for back up closed when back up on
3 + 4	3 way valve 240 VAC (2 Amps MAX)
5 + 6	Back up heater 240 VAC (10 Amps MAX)
7	Ground

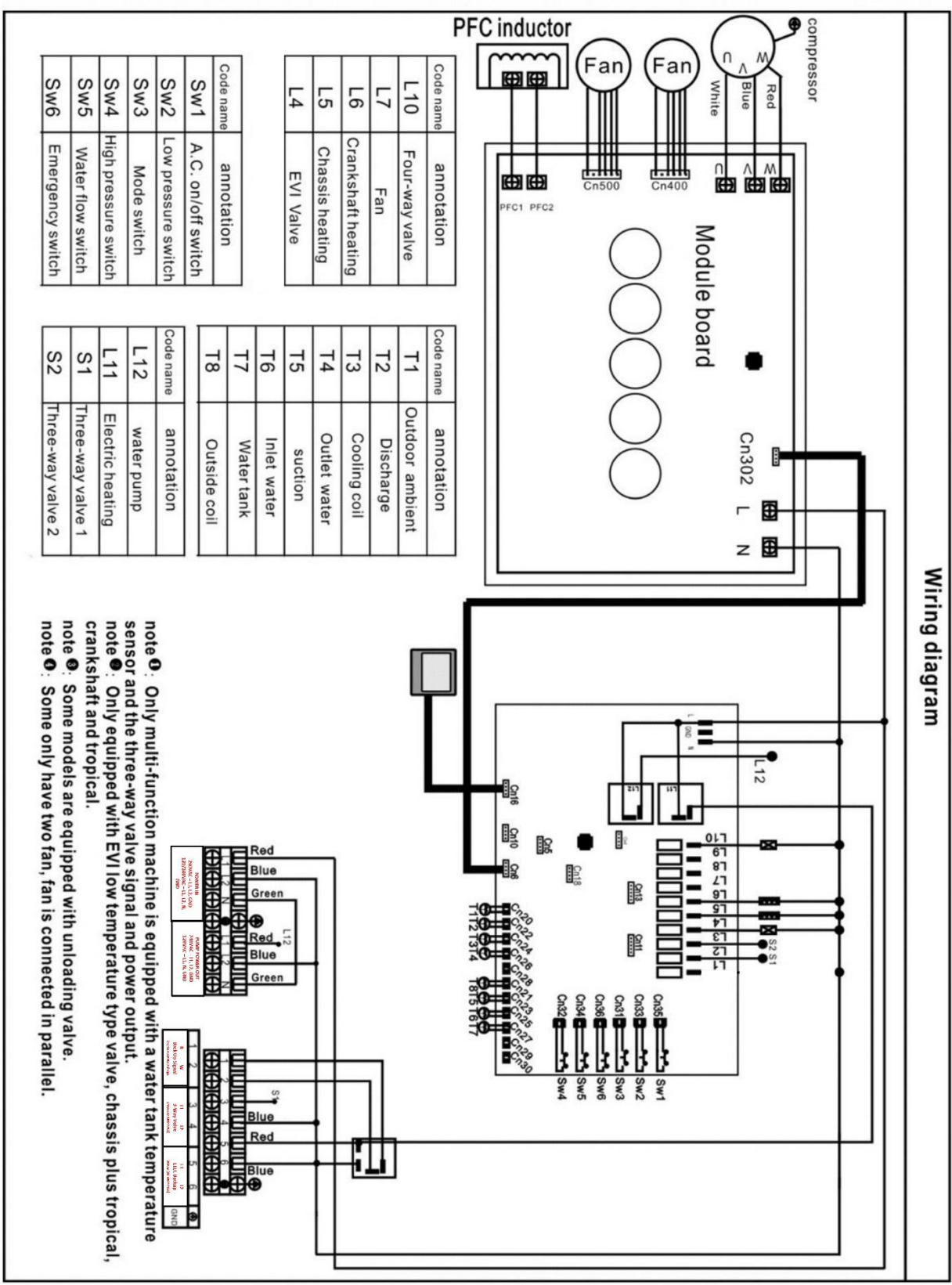

A printout of the schematic of your heat pump can be found on the inside of the door to the heat pump's electronic/refrigerent systems.

Start Up

Pre-start-up checks:

- Check the entire pipe system. Ensure the system is full and all air is completely removed. Check whether the valves are open throughout the system.
- Check the thermal insulation of the pipe works, make sure relevant pipes are appropriately insulated (hot and cold).
- Check the power supply and distribution system. Check whether the power supply voltage is correct (240 volts), the power connection screws are tight, supply power complies with the wiring diagram and heat pump specifications, and the equipment is properly grounded.
- Press and hold the on/off button on the digital controller. The water pump should start immediately, and the compressor should start shortly after. Observe and determine if there is any abnormal sound during operation. If so, stop the unit and determine the cause. The heat pump should be restarted only when the cause has been fixed and there is no more abnormal sound.
- Check whether the input power and current of the unit are within the parameters laid out in this manual under “Parameters” (C1 and C7 for 2017 and older models and A4 and A13 for 2019 and newer). If not, stop the heat pump and check it.
- Observe whether the outlet water temperature is normal. Should be 2-6 degrees above the inlet temp (Parameter Ce and Cd for 2017 and older and o2 and o3 for 2018 and newer)
- The parameters of the heat pump controller have been pre-set at the factory. We recommend that you leave these parameters as set.

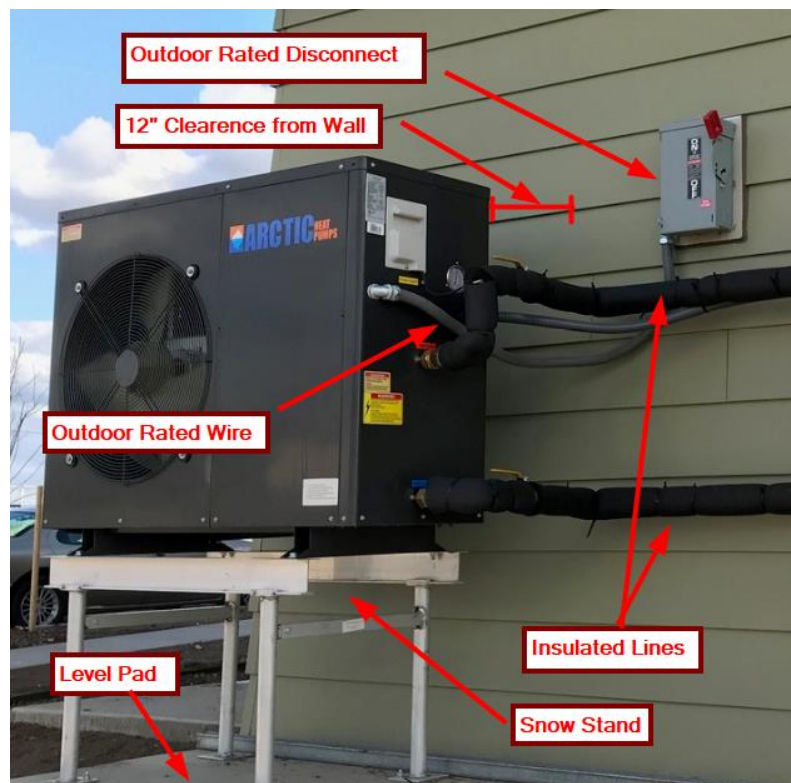

Single Tank versus Dual Tank

Single tank and dual tank optional layouts are generally decided based on the need for hot water. If you require domestic hot water, then you will use an AltSource boiler tank with a 200-foot internal copper heat exchanger for the domestic hot water. In this layout you will have a separate tank for cold water allowing you to do both heating (hot water) and cooling at the same time. A 3-way valve is used to switch the direction of the hot or cold water to the appropriate tank. If you do not need domestic hot water or do not need cooling, then you will go with a single tank design and use our composite Arctic Hybrid Tank. This tank can store either hot water or cold water and you would change this based on the season. **Note when storing cold water, a special chilling tank is needed to prevent condensation. Normal hot water buffer tanks are generally not suitable for chilling water and will void their warranty.**

Example Single Tank

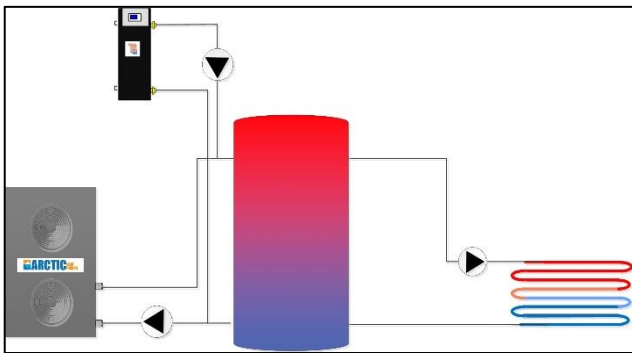

Radiant Floor Heating

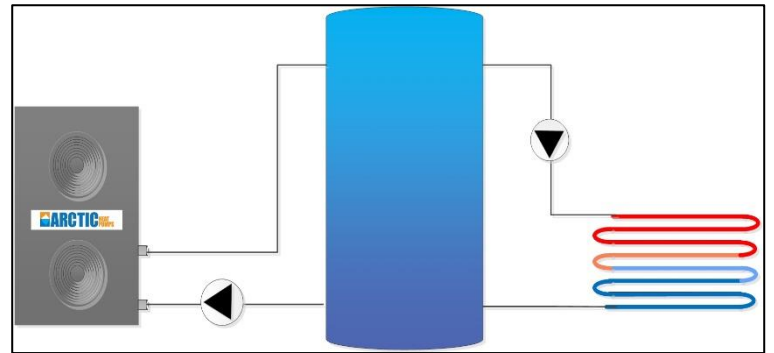

Radiant Floor Cooling

Example Dual Tank

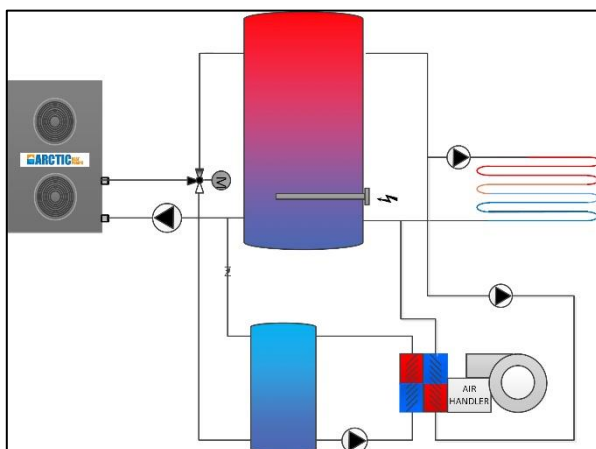

Radiant Floor Heating and Central Air Handler Heating/Cooling

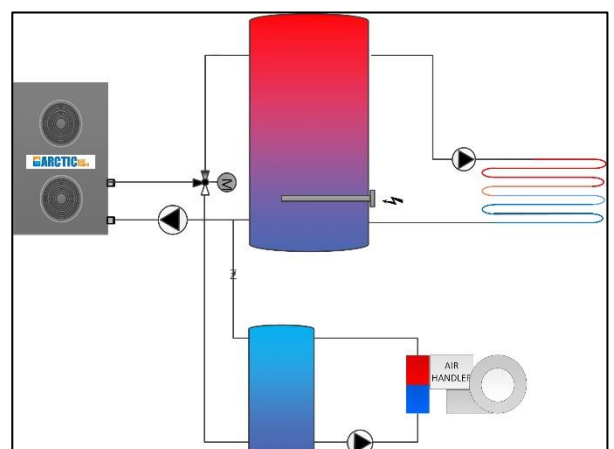

Radiant Floor Heating and Central Air Handler Cooling

The Use of the Wired Controller

Buttons and Display Symbols Explanation

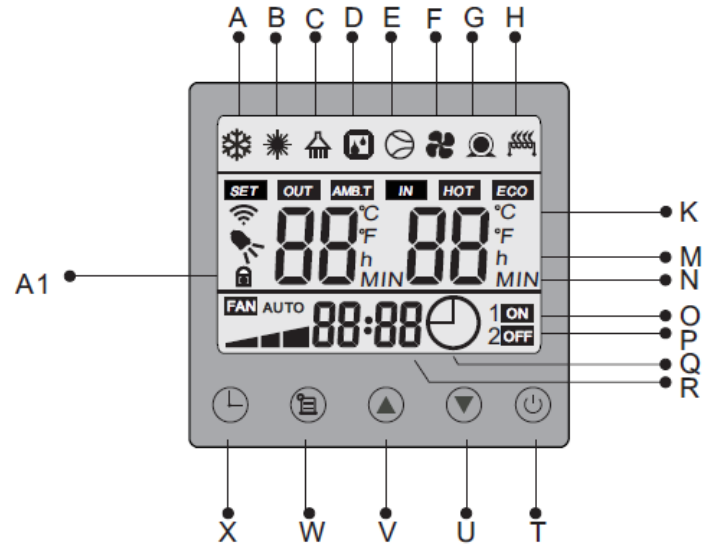

The User Interface and Functions Display is as below:

symbol	icon	instructions
A		Cool mode icon
B		Heating mode icon
C		Hot water mode icon
D		defrost mode icon
E		Compressor run icon
F		Fan run icon
G		Pump run icon
H		Auxiliary electrical heating icon
K	°C	The temperature icon
M	h	Hours icon
N	MIN	Minutes icon
O		Timing ON icon
P		Timing OFF icon
Q		Set the time icon
R	88:88	Time icon
T		The unit switch
U		Down button icon
V		Up button icon
W		Function button icon
X		Timing button icon
A1		Lock icon





Wired Controller Operations

Keyboard Locking / Unlocking Operation



If no buttons are pressed on the controller for 30 seconds, the unit will switch to locked mode automatically and the lock icon  will display on the wired controller. This means that the keys (buttons) are locked. To unlock, long-press the on/off  button for 3 seconds.

Turning the Unit ON/OFF

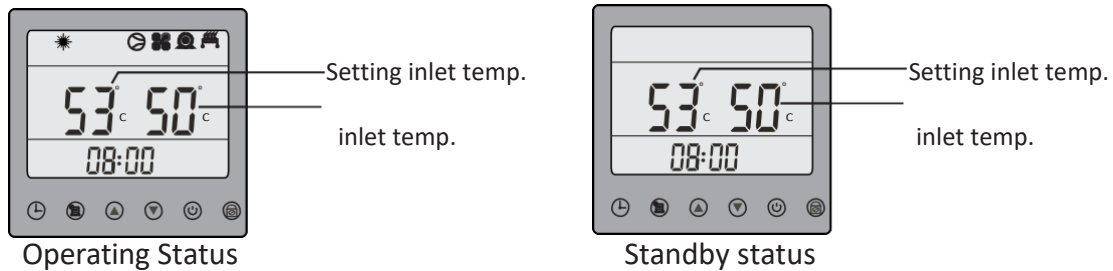
Under standby status (electric power is present, but unit is not operational), the display will look as shown in the figure below on the right. Press the on/off  button to turn the unit on. The operation mode icon will display on the wired controller (cool or hot water mode or both). Long-press the on/off  button again, and the unit will turn off and show the Standby display.





Modifying the Temperature Setting

While in operating status, **short pressing** the  button or  button will modify the temperature setting. For example, if in hot water mode, it will modify the hot water tank temperature setting. If in cooling condition mode, it will modify the setting of the **returning inlet temperature** to the heat pump.

Mode Select Operation

While in operating status, **long-press** the  button to change the operational mode.

		
Hot water mode	Cooling mode	Hot water + Cooling mode



In *hot water mode*, the temperature on the left side of the wire controller is the temperature setting for the hot water tank, and on the right side is the actual temperature of the hot water tank.





In *cooling mode*, the temperature on the left side of the wire controller is the temperature setting for the returning water to the heat pump and on the right side is the actual temperature of the returning water.









In *hot water & cooling mode*, **the unit default priority is the hot water mode**. So, the unit will run the hot water mode at first, and the temperature on the left side is the temperature setting for the hot water tank, while on the right side is the actual temperature of the water in the hot water tank. When the hot water tank temperature reaches its setting, the unit will switch to cooling mode automatically. Now the temperature on the left side of the wire controller is the temperature setting for the water returning to the heat pump, and on the right side is the actual temperature of the returning water.

Note: The room control strategy for heating and cooling is not controlled by the heat pump. That is done by the thermostat of the air handler or radiant heating zone. For example, the heat pump attempts to maintain a buffer tank temperature that is enough for the zone heaters to do the job of heating or cooling that space. When in heating mode, the Heat Pump only controls the temperature of the buffer tank which is then used by an additional controller to heat zones. With cooling, the heat pump keeps the cooling buffer tank at the set temperature and the secondary fan coil or air handler distributes this cold water as required to cool the space



Forced Defrost

In heating mode, hold  to run defrost mode, and the defrost icon  will flash.

Clock Setting

Short press the time button  and the time of the wire controller will flash. At this time press  button to confirm, and the hours will be flashing. Press  or  to change the hours. Press the  button again to change the minutes. When correct, press  button to set the new time and exit setting.













Changing Between Celsius & Fahrenheit

To switch between °C and °F, long-press the function button  and ON/OFF button  at the same time until it changes. **Note:** In Fahrenheit, the display will only show the current temp of the tank. To access the set temp, unlock the controller and press the up or down arrow to adjust the set temp. This will time out and only the current temp will be displayed.





Factory Reset

To reset the controller to factory, press the TEMP UP  and TEMP DOWN  buttons at the same time until it beeps. **Advanced parameters need to be checked after factory reset.**

Timer ON/OFF Settings

While in standby status, long-press the time button  and  button for 10 seconds. the icons  1 **ON** and hours will flash. Now press  or  to change the on-time hours. Short press  again, and the time for on-time minutes can be changed. Now you have finished the unit's on-time setting. Then short press the  button and  **OFF** icons and hours will flash. Now press  or  to change the off-time hours. Short press  again and the off-time minutes can be changed. Short press  button one more time to finish the timer settings and exit. (See sequence diagram next page).



Cancelling Timer Operation

Canceling the timer operation implies that the timer will not interrupt the operation of the heat pump. To cancel the timer Long press the  and  button, entering the timer setting, and then press the  button. unit will cancel the group 1 timer "ON". Next the group 1 timer and "OFF" will be flashing, press  to cancel group 1 timer "OFF" setting. Repeat steps for canceling timer 2.

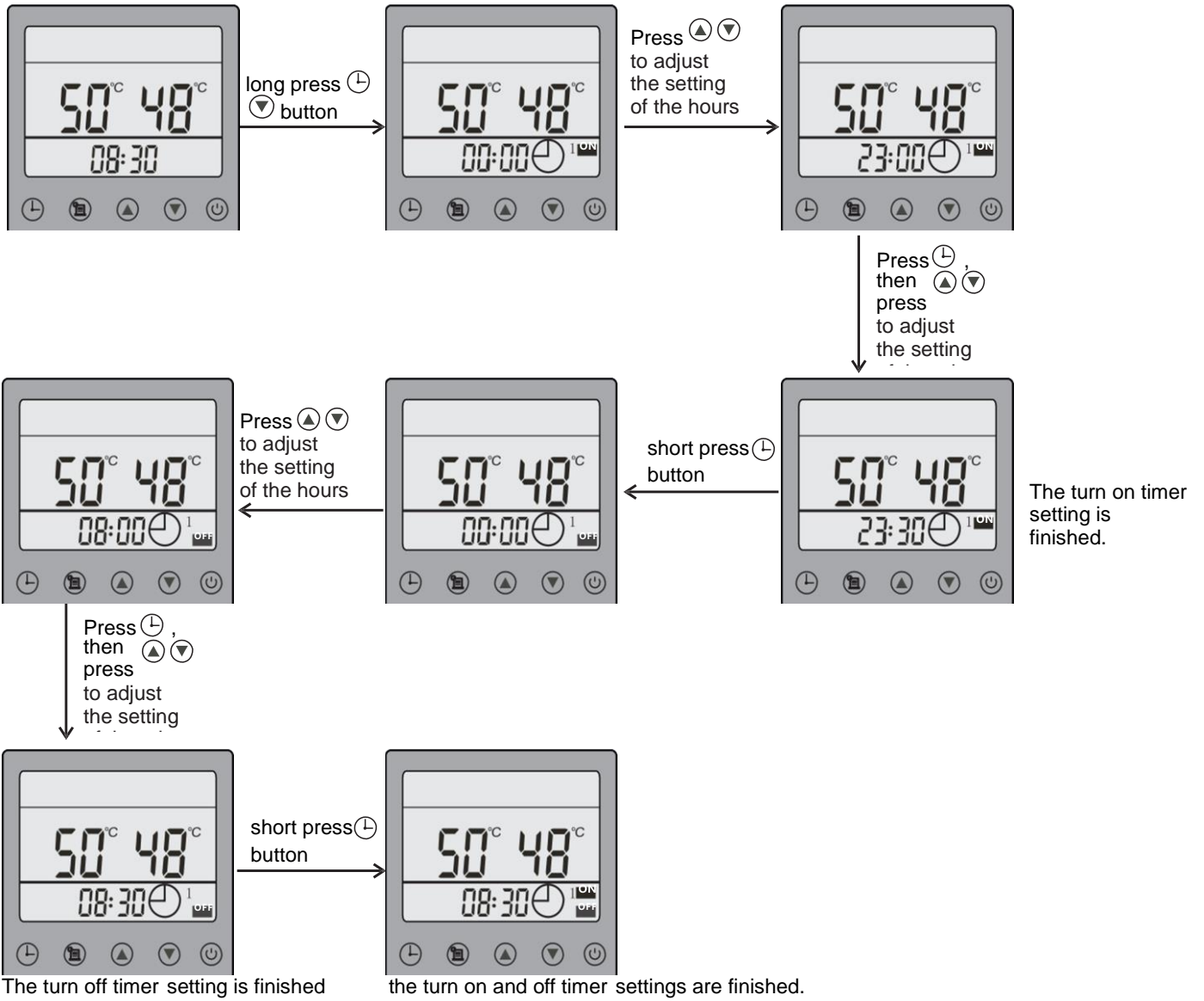
Timer Programming



Force the Backup to Run



To force the heat pump back dry contact to close press the TEMP UP  and FUNCTION  button at the same time. The backup will stay on until it reaches the setting temperature.

Selecting Energy Saving Mode, Quiet Running Mode, and Fast Heating Mode

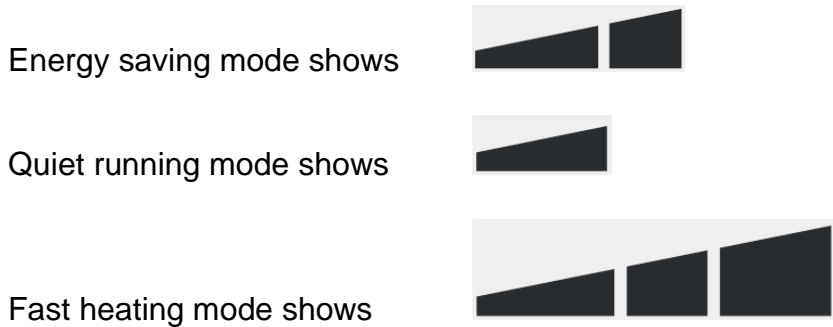
On main screen with the controller unlocked long press  for 5s to select energy saving mode, quiet running mode and fast heating mode.



Checking of State Parameters

In the main interface Press  to enter the state parameter interface. Then press  or  button to navigate to the state parameters.

2018 - Current

Display	Meaning	Display	Meaning
o1	Water tank temperature	A5	Main elec. Expansion valve degree
o2	Water inlet temperature	A6	Cool coil temperature
o3	Water outlet temperature	A7	DC bus voltage
o4	Ambient temperature	A8	IPM module temperature – NOT USED
o5	NOT USED	A9	Real-time power
o6	Auxiliary elec. Expansion valve degree	A10	Dc motor speed
A1	Discharge temperature	A11	High pressure
A2	Coil temperature	A12	Low pressure
A3	Suction temperature	A13	AC input voltage x 100
A4	AC input current	A14	Frequency of compressor operation

Maintenance and Repair

Notes

- Keep the unit in a dry environment that is clean and well ventilated. Clean the evaporator fins regularly (once per 1-2 months) to maintain high exchange efficiency and save energy.
- The unit has self-diagnosis built into it and as such will display error codes on the control display if any items need attention.

Antifreeze Protection for Cold Climates

In most heating climates antifreeze protection is of great importance to the operation security and service life of the unit, therefore, please be sure to follow the instructions below:

- The hot water piping must be well insulated to reduce heat loss.
- Cooling piping will condensate so to avoid this use waterproof pipe insulation on chilled lines.
- Limit the distance of the piping run into the house. Shorter pipes will lose less heat.
- Ensure the drain plug on the bottom of the heat pump pan is elevated 24" so that ice buildup does not plug the drain.
- The unit is equipped with both a drain pan and compressor low temperature supplemental heating trace to ensure proper operation in low temperature.
- Polypropylene glycol should be used in an appropriate ratio corresponding to the lowest possible ambient temperature (see table below).
- System pressure drop will increase by 25% with 35% water to glycol mixture so this must be considered when sizing circulation pumps.

Percent Glycol Concentration Required			
Temperature		For Freeze Protection	For Burst Protection
C	F	Volume %	Volume %
-7	20	18	12
-12	10	29	20
-18	0	36	24
-23	-10	42	28
-29	-20	46	30
-34	-30	50	33
-40	-40	54	35
-46	-50	57	36
-51	-60	60	37

WARNING: DO NOT EXCEED 50% GLYCOL AS THE FLUID WILL BE TOO VISCOUS AND PREVENT THE CIRCULATION PUMPS FROM WORKING

Error Code Table

Code	Fault	Solution
E01	Discharge temp. sensor protection	Check if the sensor is disconnected or short-circuited
E05	Outdoor coil temp. sensor protection	Check if the sensor is disconnected or short-circuited
E09	Suction temp. sensor protection	Check if the sensor is disconnected or short-circuited
E13	Cooling coil temp. sensor protection	Check if the sensor is disconnected or short-circuited
E18	Outlet water temp. sensor protection	Check if the sensor is disconnected or short-circuited
E19	Return water temp. sensor protection	Check if the sensor is disconnected or short-circuited
E20	Water tank temp. sensor protection	Check if the sensor is disconnected or short-circuited
E21	Controller communication error	<ol style="list-style-type: none"> 1. Check if the controller is matched with the main board 2. Check if the communication cable (extension cable) is connected correctly and if it is short-circuited 3. Check if the communication cable (extension cable) is connected to the right terminal on the main board
E22	Outdoor ambient temp. sensor protection	Check if the sensor is disconnected or short-circuited
E26	Indoor and outdoor unit communication error	<ol style="list-style-type: none"> 1. Check if the communication cable between indoor unit and outdoor unit is connected correctly 2. Check if the main board of indoor unit is matched with the main board of outdoor unit 3. Replace the board of indoor unit or board of outdoor unit
E28	Outdoor EE error	Contact the distributor
E33	Main loop high pressure sensor failure	Check if the sensor is disconnected or short-circuited
E34	Main loop low pressure sensor failure	Check if the sensor is disconnected or short-circuited
EA	EEV loop low pressure sensor failure	Check if the sensor is disconnected or short-circuited
EB	Main loop high pressure protection	Check if the sensor is disconnected or short-circuited
EC	Main loop low pressure protection	<ol style="list-style-type: none"> 1. Check if there is a refrigerant leak 2. If a refrigerant leak is confirmed, fix the leakage point, vacuumize the system and fill with refrigerant according to the information on the technical label
ED	EEV loop low pressure protection	Check if the sensor is disconnected or short-circuited
FE	Start pressure difference protection	Contact the distributor
FF	Operation pressure difference protection	Contact the distributor
r01	IPM module over temperature protection	Contact the distributor
r02	Compressor abnormal start	Contact the distributor
r06	Compressor phase current protection	Contact the distributor
r10	AC high/low voltage protection	Contact the distributor
r11	DC-link high/low voltage protection	Contact the distributor
r13	IPM module error	Contact the distributor
r20	Compressor protection	Contact the distributor
P01	Water flow switch protection	Check that the water system, water pump, and water flow switch is normal
P02	High pressure protection	<ol style="list-style-type: none"> 1. Check if the inlet water temp. is too high or if water inlet is blocked 2. Check if the fan blades are too dirty that influence the heat exchange efficiency of the heat exchanger 3. Check if the refrigerant amount is too high 4. Check if the water tank temperature setting is too high
P06	Low pressure protection	<ol style="list-style-type: none"> 1. Check if there is a refrigerant leak 2. If a refrigerant leak is confirmed, fix the leakage point, vacuumize the system and fill with refrigerant according to the information on the technical label.
P11	High discharge temp. protection	<ol style="list-style-type: none"> 1. Check if the water system is normal, check if the water flow volume is small

		2. Check if the unit operation is normal, check if the discharge temp. and system pressure is normal
P15	Large temp. difference between water inlet and outlet	1. Check if the water system is normal, check if the water flow volume is small 2. Check if the unit operation is normal, check if the discharge temp. and system pressure is normal
P16	Low outlet water temp. protection	1. Check if the water system is normal, check if the water flow volume is small 2. Check if the unit operation is normal, check if the discharge temp. and system pressure is normal
P19	AC current protection	Contact the distributor
P27	High cooling coil temp. protection	Check if the fan blades are too dirty that influence the heat exchange efficiency of the heat exchanger
P30	Cooling coil temp. antifreeze protection	Unit antifreeze protection operation
PA	High outlet water temp. protection	1. Check if outlet water temperature is too high 2. Check if the water outlet temp. sensor is in failure 3. Check if the setting water temperature is too high
PC	Ambient temperature too high or too low	1. Check if the current ambient temperature is out of the units working ambient temperature range 2. Check if the ambient temperature sensor is in failure

Wiring Diagrams

Controller Board

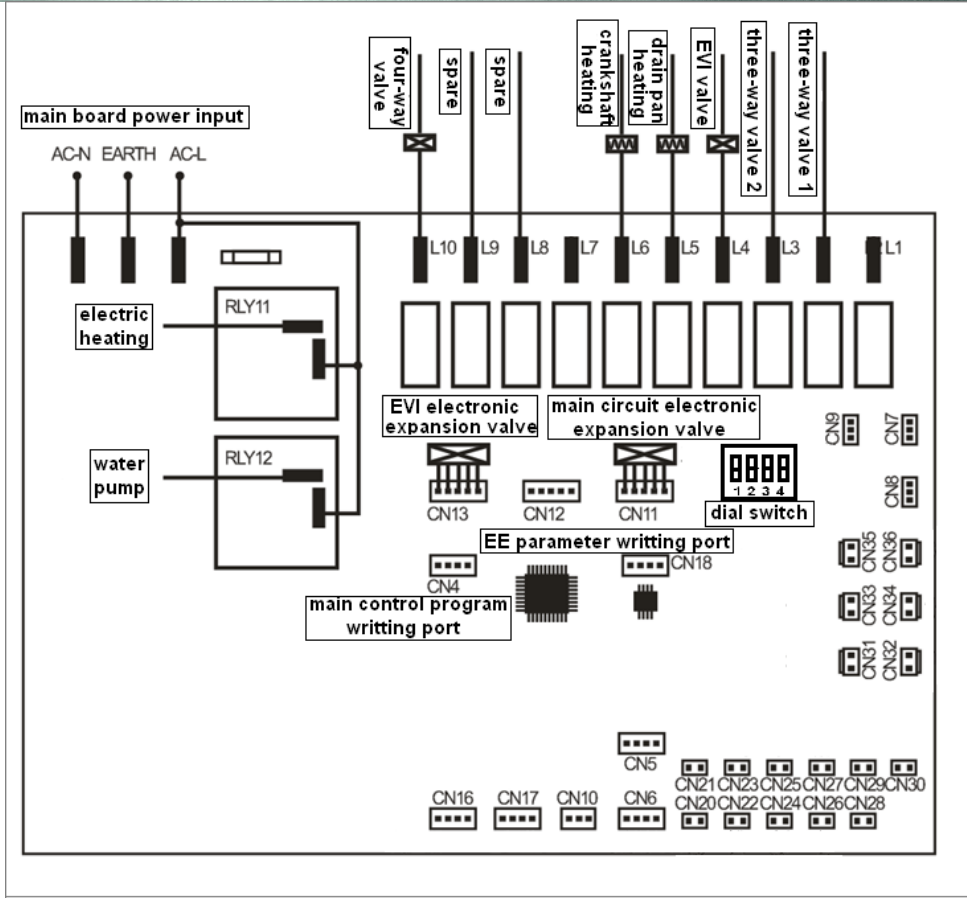
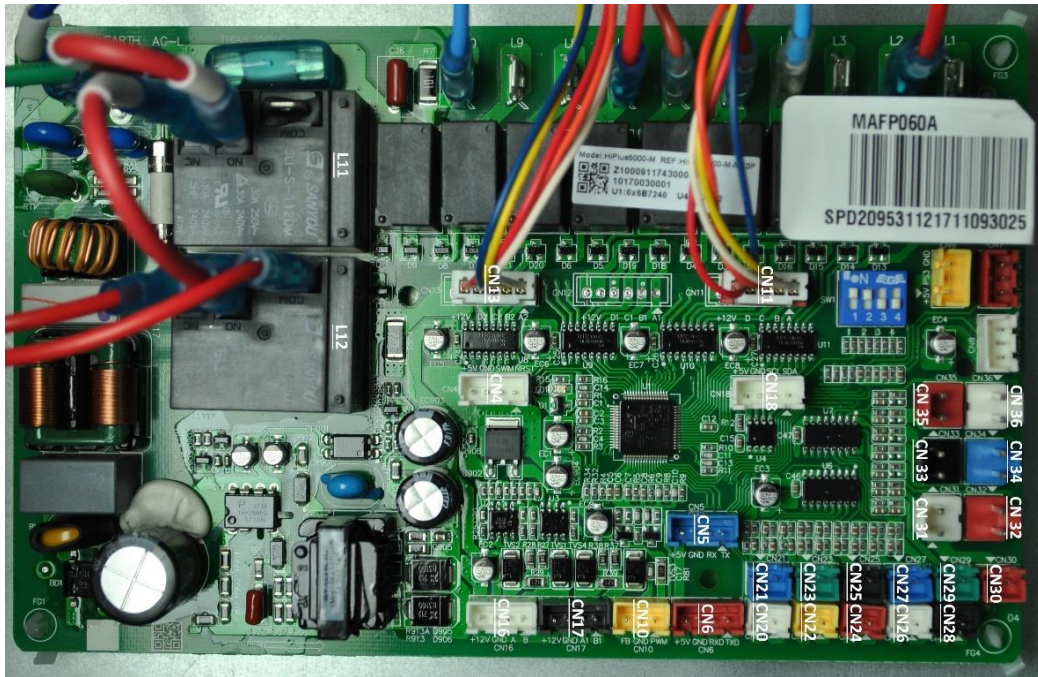

- | | | |
|----------------------------|--------------------------|-------------------------|
| CN7, CN8, CN9, CN10: spare | CN20: ambient temp. | CN27: water tank temp |
| CN31: mode switch | CN21: coil temp. | CN28, CN29, CN30: spare |
| CN32: high pressure switch | CN22: discharge temp. | |
| CN33: low pressure switch | CN23: suction temp. | CN16: wired controller |
| CN34: water flow switch | CN24: cooling coil temp. | CN17: Modbus available |
| CN35: A.C. online switch | CN25: water inlet temp. | CN5: computer monitor |
| CN36: emergency switch | CN26: water outlet temp. | CN6: drive board |

ARCTIC HEAT PUMPS

Arctic Heat Pump Control Board

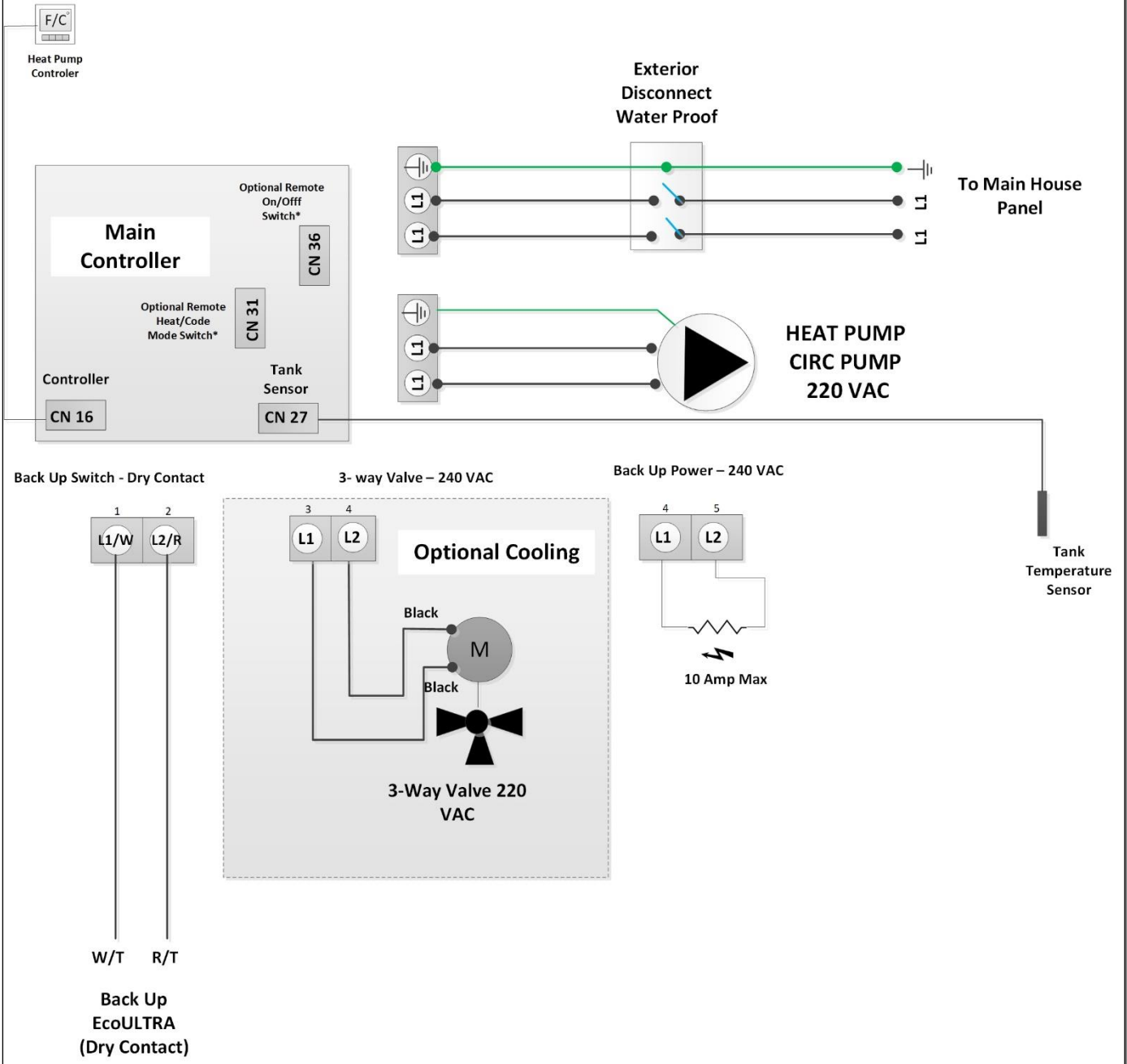

Wiring Diagram Single Tank - Basic

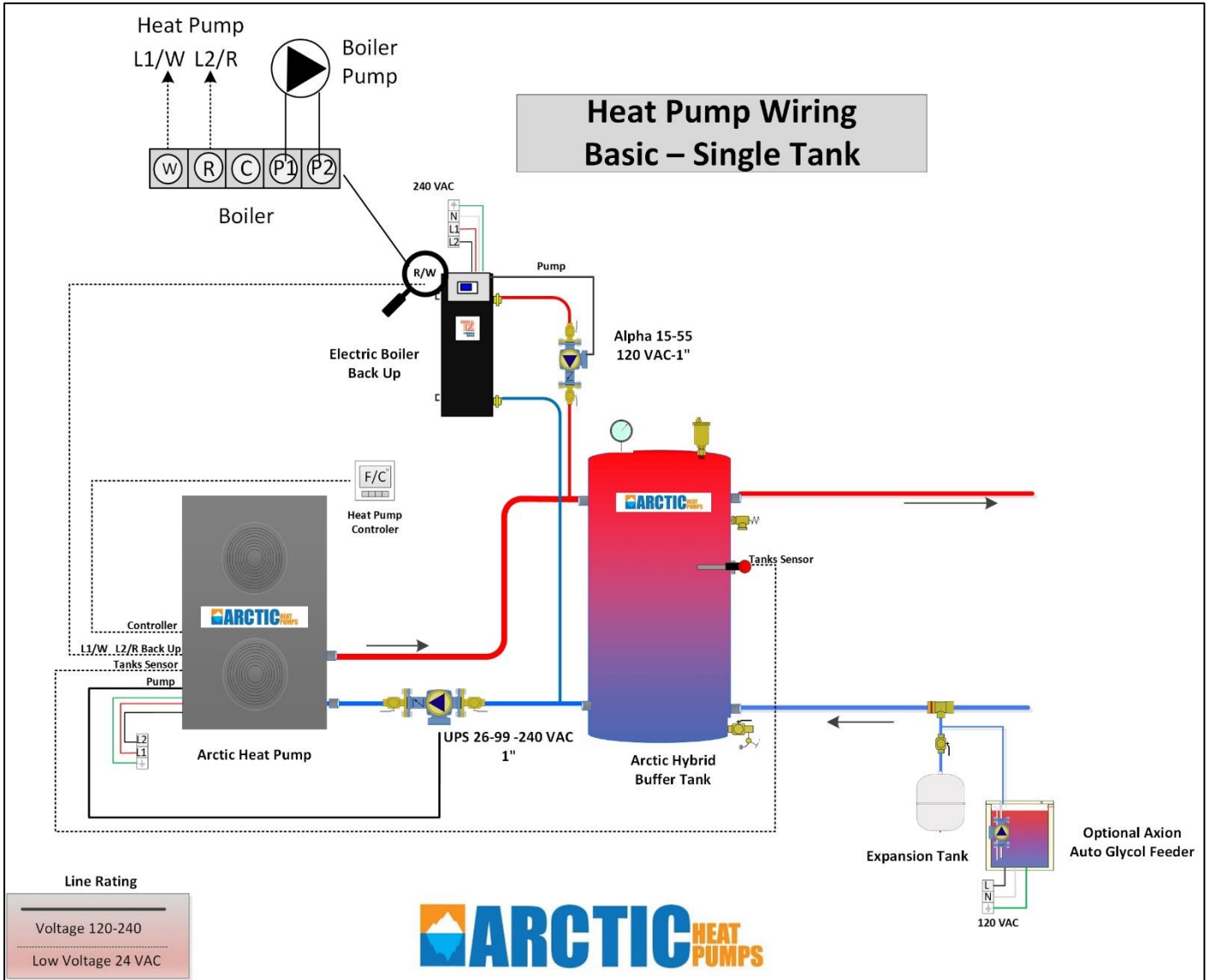

Wiring Diagram Single Tank – HBX

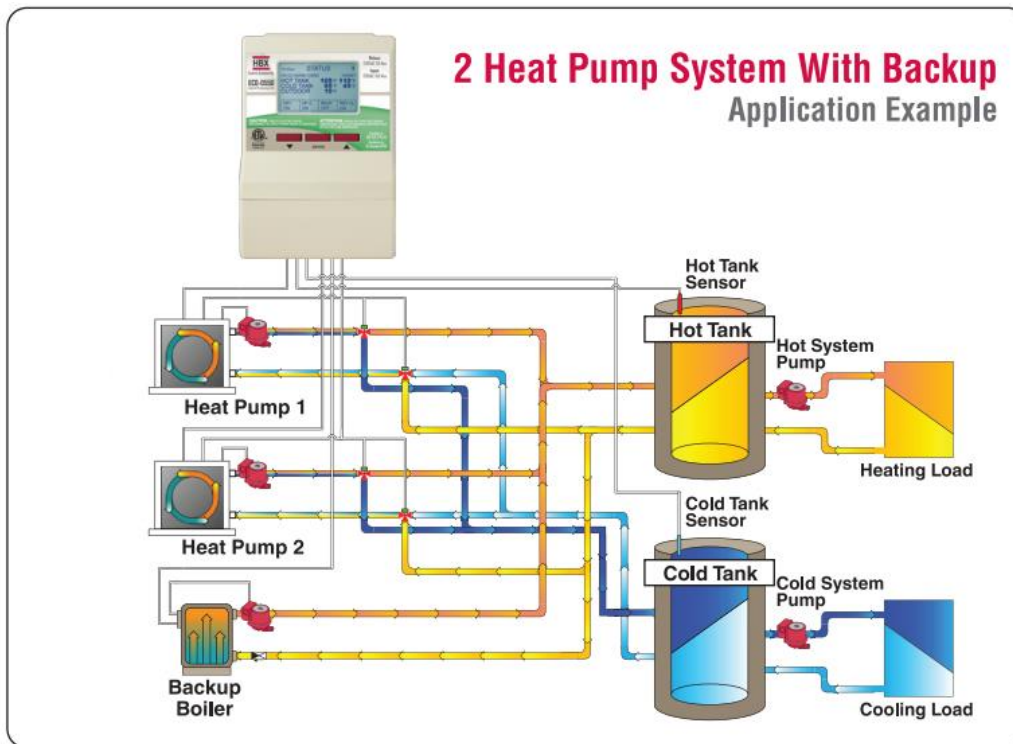

Overview

Introducing the simplest, most intuitive control available to the geothermal industry: the ECO-0600, now with the Thermolinx™ Hydronic Network, allowing you to control your geothermal system from the palm of your hand. The ECO-0600 covers a multitude of geothermal applications and can accommodate for heat pumps with a backup boiler, reversing valve and a system pump for complete system coverage with the ability to control single or dual tank systems.

Heat Pump & Backup Control

The ECO-0600 stand-alone control is designed to control equipment in a two pipe, single or dual tank, hydronic heating, or cooling system. The ECO-0600 can control up to four (4) heat pump stages (air-to-water or water-water) or chillers and a reversing valve with outdoor temperature reset control.

This powerful control can also control a backup heat source (boiler) while operating three (3) heat pump stages. The backup heat source can be activated by a few different options based on outdoor or tank temperatures. The control can manage single tank applications as well as applications with separate hot and cold tanks.

Eco Switch Energy Clock

The Eco Switch feature allows you to lockout your heat pumps and run only the backup boiler on a timed schedule, allowing you to save on energy and lower your utility bills during peak time periods. The schedule can be set for four separate times per day for weekends and weekdays.

Remote Access Anytime, Anywhere

Used in conjunction with the free HBX Sensorlinx™ mobile app, users can control their geothermal system remotely from their smartphone or tablet devices with the ability to adjust heat pump and backup parameters, monitor tank temperatures, equipment operation status and receive alarm notifications.

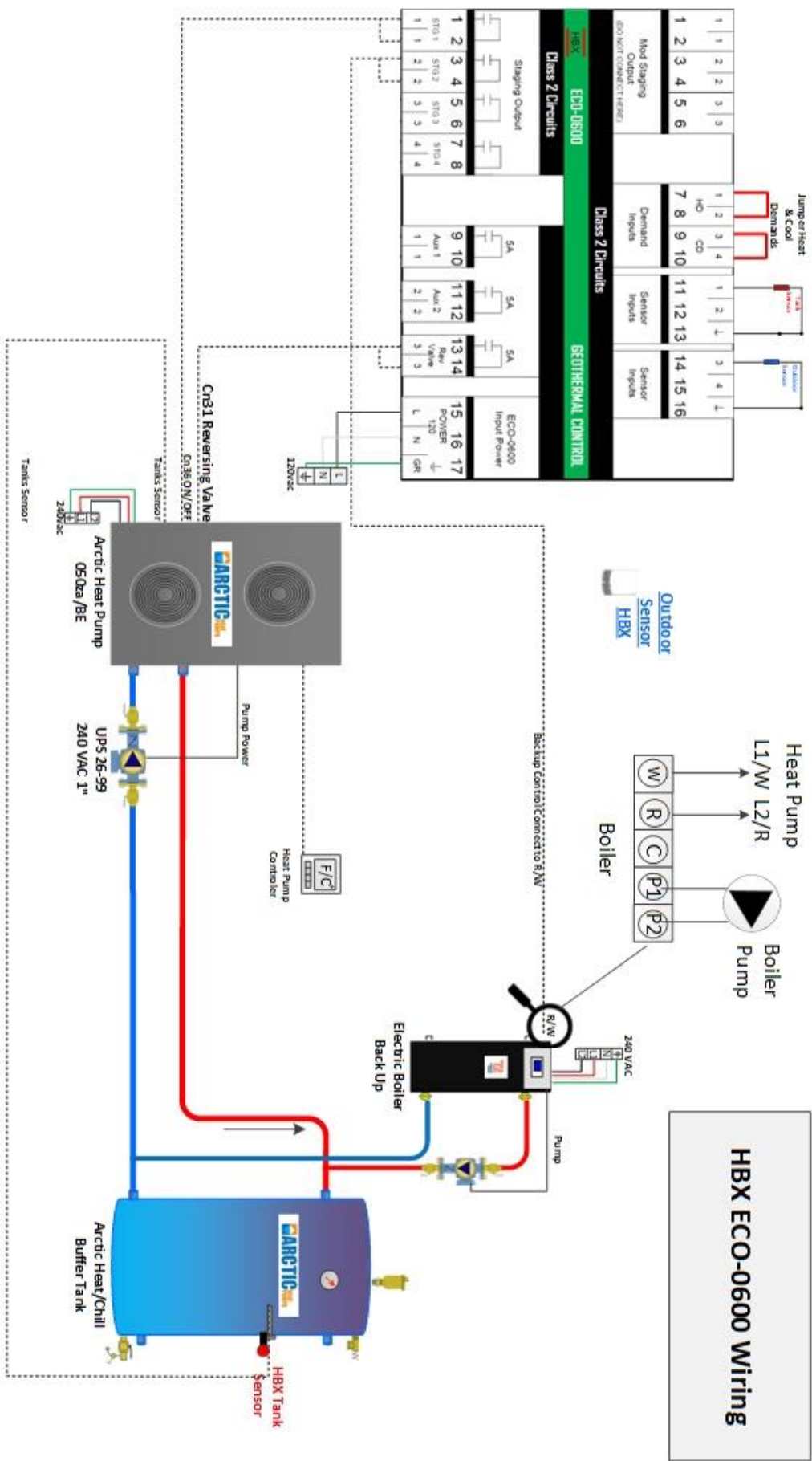

HBX ECO-06000 Wiring

Line Ratings
 Voltage 120-240
 Low Voltage 24 VAC <



Wiring Diagram Dual Tank - Basic

Heat Pump Wiring Basic - Dual Tank

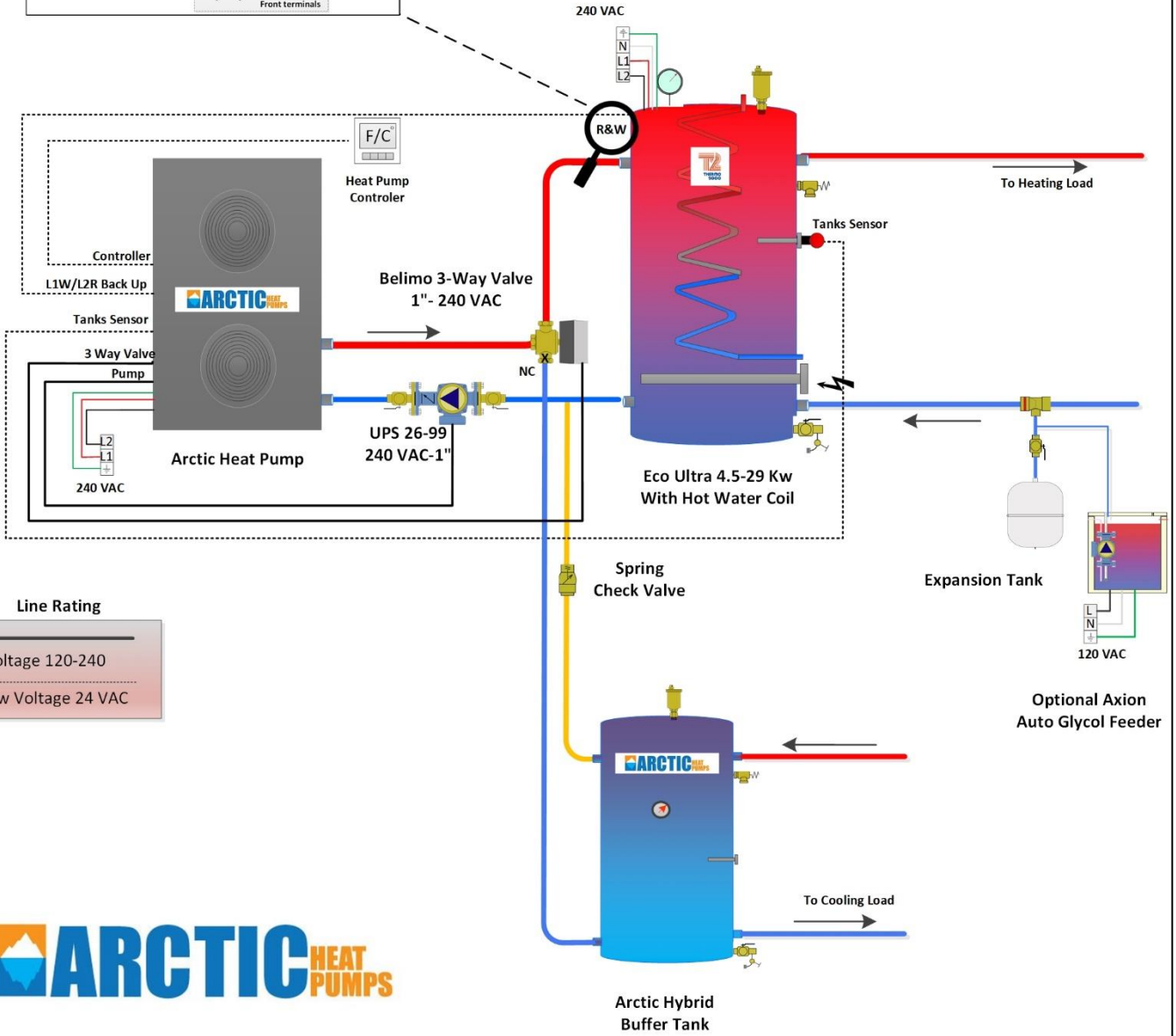
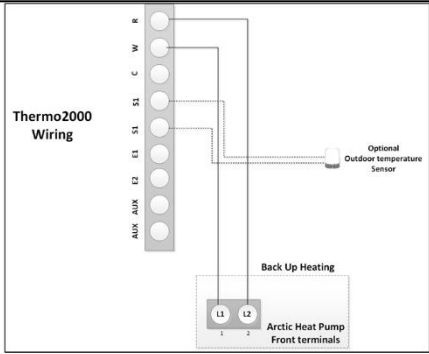

Wiring Diagram Dual Tank – HBX

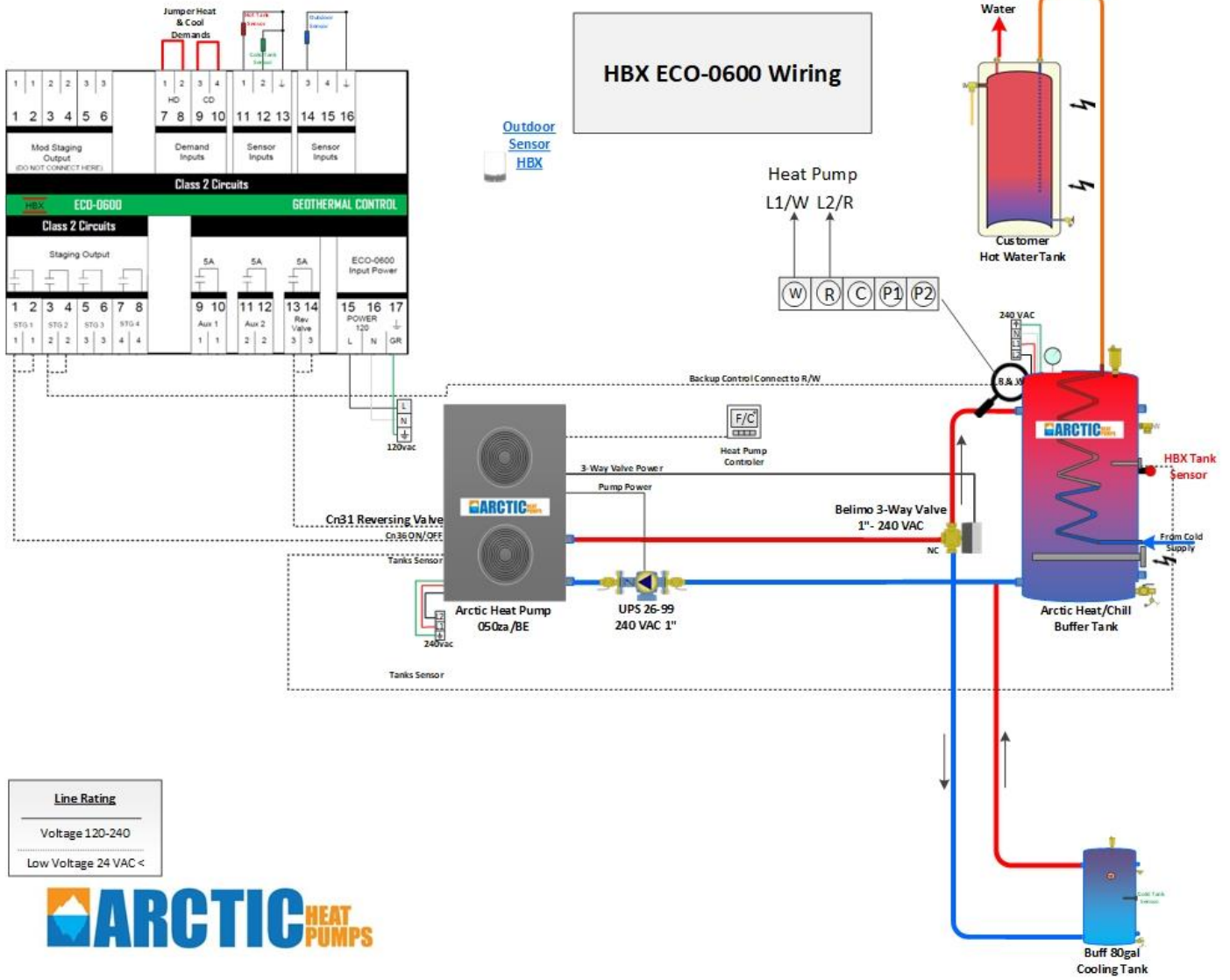

Intelligent Defrost

By default, the arctic heat pump is designed to defrost itself as needed. The algorithm is factory supplied based on optimized performance parameters for cold climates. These are based on coil temperature differentials and compressor run times. When a unit enters defrost it will go through various stages including a reverse from heating to cooling, removing some heat from the buffer tank. This provides heat to the coils to defrost any frost that has formed. When it finishes it will turn on the fan to hi speed to dry the coil before resuming back to heating.

Enter Defrost Mode

1. When ambient temperature is detected to be -10°C or colder, and coil temp. is -7°C or colder, and unit has been working for 45min, then the unit will enter defrost mode.

OR

2. When ambient temperature is detected to be 18°C or lower and coil temp. is -10°C or lower, and unit has been working for 90min, or when unit has been working for 45min and ambient temperature - coil temperature is $\geq 10^{\circ}\text{C}$ unit will enter defrost mode.

Exit Defrost Mode

The defrosting operation ceases when any one of the following conditions occurs:

1. Defrosting operation duration ≥ 8 minutes.
2. The air side heat exchanger refrigerant outlet temperature $\geq 13^{\circ}\text{C}$.
3. The $|\text{inlet water temperature} - \text{outlet water temperature}| \geq 18^{\circ}\text{C}$ for more than 10 seconds.
4. Water side heat exchanger water outlet temperature $\leq 5^{\circ}\text{C}$.

Mild Climate Defrost

In Midler climates with high humidity the default defrost settings may not be enough to remove all ice buildup from the unit's coil. Below are adjustments that can be made to the advanced parameters of the heat pump to allow the unit to defrost in milder climates:

1. Unlock the controller (press the power button for 5 seconds)
2. Press the Function button (2nd from left) for 5 seconds until "00" appears at the bottom of the screen. (00 is the parameter number)
3. Use the up arrow to cycle to the desired parameter.
4. Short press the function button and the selected parameters value will begin to blink.
5. Use the up and down arrows to adjust the settings of the selected parameter.
6. Short press the function button to lock in your changes. The selected parameters value will stop blinking.
7. Short press the power button to exit the advanced parameter menu.

Parameter Number	Default Value	Mild Defrost Value
29	45min	30min
30	-7°C	-3°C
31	-10°C	0°C
32	10°C	8°C
33	45min	35min
34	8min	10min

Back Up Heating

The Arctic Heat Pump has an intelligent back up heating system that allows it to signal a backup heating source when the **heat demand exceeds the heat production**, such as during very cold temperatures. It also can call on a backup heat source in case of a **failure or emergency**. The backup heating control signal (closing of a dry contact 1, 2) is built into the unit and will function as follows.

Turn On

The backup heater will be called upon when all the items in a, b, c, d have occurred **OR** item **e** is met.

- a. System is in Heating or Water Heating mode **AND**
- b. Ambient temperature is $<18^{\circ}\text{C}$ **AND**
- c. Water tank temp setting– Actual Water tank temperature $> 5^{\circ}\text{C}$ **AND**
- d. Compressor has worked for 30 consecutive minutes and temperature rise is less than 2°C .

- e. System is in failure mode or compressor has been turned off for 5 min and no condition was reached that would normally cause a **Turn Off** (see below)

Turn Off

1. The electric back up heater will turn off when any of the conditions have been met.
 - a. Water tank temperature \geq setting temperature **OR**
 - b. Unit is in cooling or defrost mode **OR**
 - c. “Emergency” or “AC Remote On” switch is (activated)

Back Up Heater

Arctic Heat Pumps are designed to work with Thermo2000 Boilers but can be used with other manufactures. If you are using the AltSource buffer/boiler tank, then you can simply connect the contacts (1 & 2 terminals) on the Heat Pump to the Y and W terminals on the AltSource tank. If you are using a Mini ULTRA or BTH ULTRA boiler you will do the same but also you need to connect the supply pump to the Pump terminals on the external boiler. If you are not using a dry contact back up heating source and need to connect a direct back up heating element such as a water tank, please contact us for modification instructions for a contactor. It is not suggested to directly connect a heating source to the 240 VAC electric heat terminals on the Arctic Heat Pump as the load could blow the main fuse on the board.

When the Arctic Heat Pump calls for supplemental back up heat, the dry contact behind terminal 1/2 will close, signaling the boiler heating terminals R & W to begin contributing energy via its electric heating elements. The T2 Boilers will do so systematically, only applying as much heat energy as needed (sequencing multiple elements as needed). When the buffer tank reaches its target temperature (set up in the heat pump controller), the call for back up heat will end, and the boiler will turn off. During this period, the Arctic Heat Pump will continue to stay on as long as there is thermostatic call regardless of whether the energy is coming from the heat pump or the backup heater. In this way the backup heater only supplements the Heat Pump. **Note:** After -30 C the Heat pump will turn off and the backup heat will be the primary heating source. The heat Pump will display a PC Error when the external temperature reaches this level.

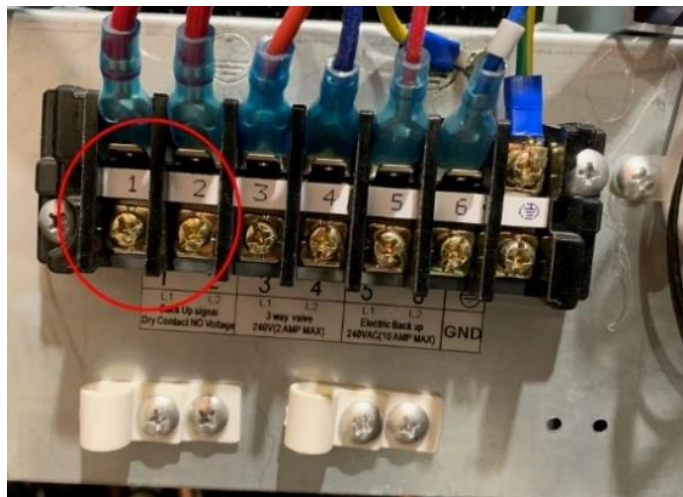

Back Up Terminal on Heat Pump



Back Up Terminals on Boiler

AltSource Integration

AltSource is a unique buffer/boiler tank that can fully control most hydronic systems. The AltSource can be configured with 4.5 Kw to 29 Kw back up electric power sources. The 50 or 70 US-gallon storage capacity makes this tank the ultimate back up heating source for any Air Source Heat Pump or Geothermal Hydronic System. Optional Domestic Internal Hot Water Coil is available on these tanks.

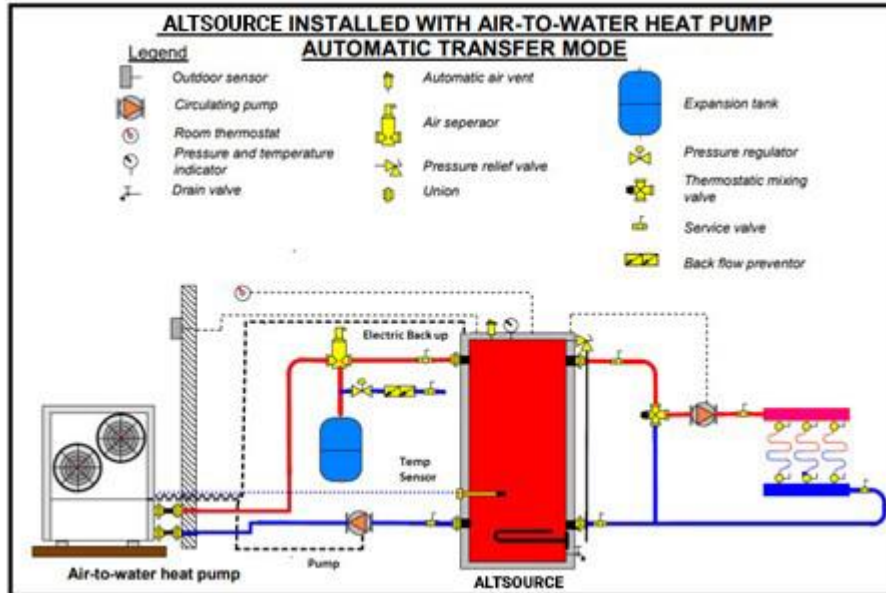

If you have purchased an AltSource boiler buffer tank to back up your heat pump, then the integration between the heat pump and boiler is made by connecting the R and W terminals on the Heat pump to the R and W terminals on the AltSource tank. This is done by removing the front access panel. A #16 or #18 2-wire is suitable for this connection.

External Boiler Integration

The Thermo2000 Mini or BTH ULTRA boilers are the most cost effective and reliable external backup systems and pair well with all the Arctic Heat Pumps. These Boilers can be configured with 3 Kw to 36 Kw back up electric power sources.

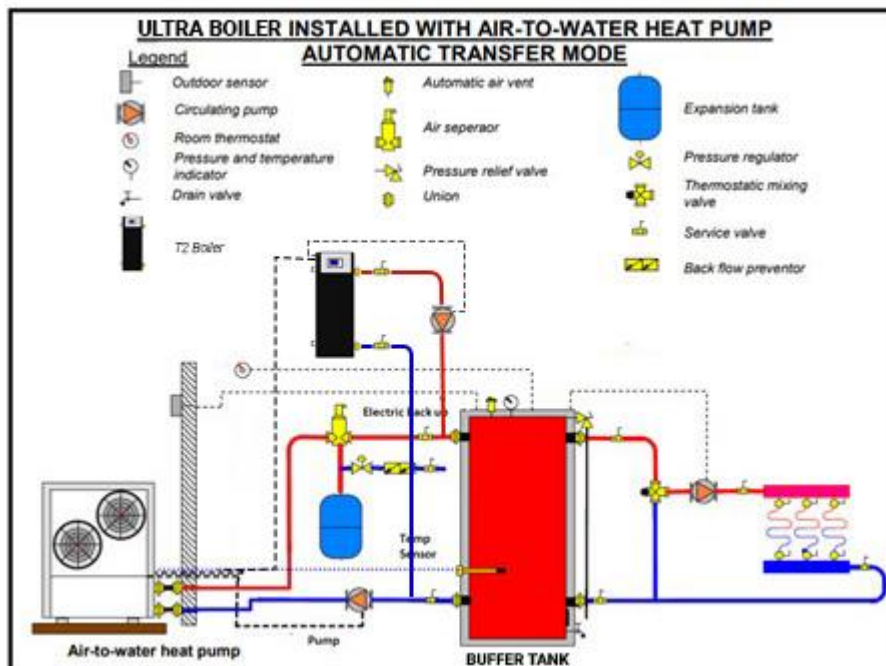

If you have purchased an ULTRA external boiler to back up your heat pump, then the integration between the heat pump and boiler is made by connecting to the 1/2 terminals on the Heat pump to the R and W terminals on the ULTRA external boiler. This is done by removing the front access panel. A #16 or #18 2-wire is suitable for this connection. **NOTE:** With this configuration you will also need to connect the Pump to the P1 P2 terminals on the ULTRA boiler.

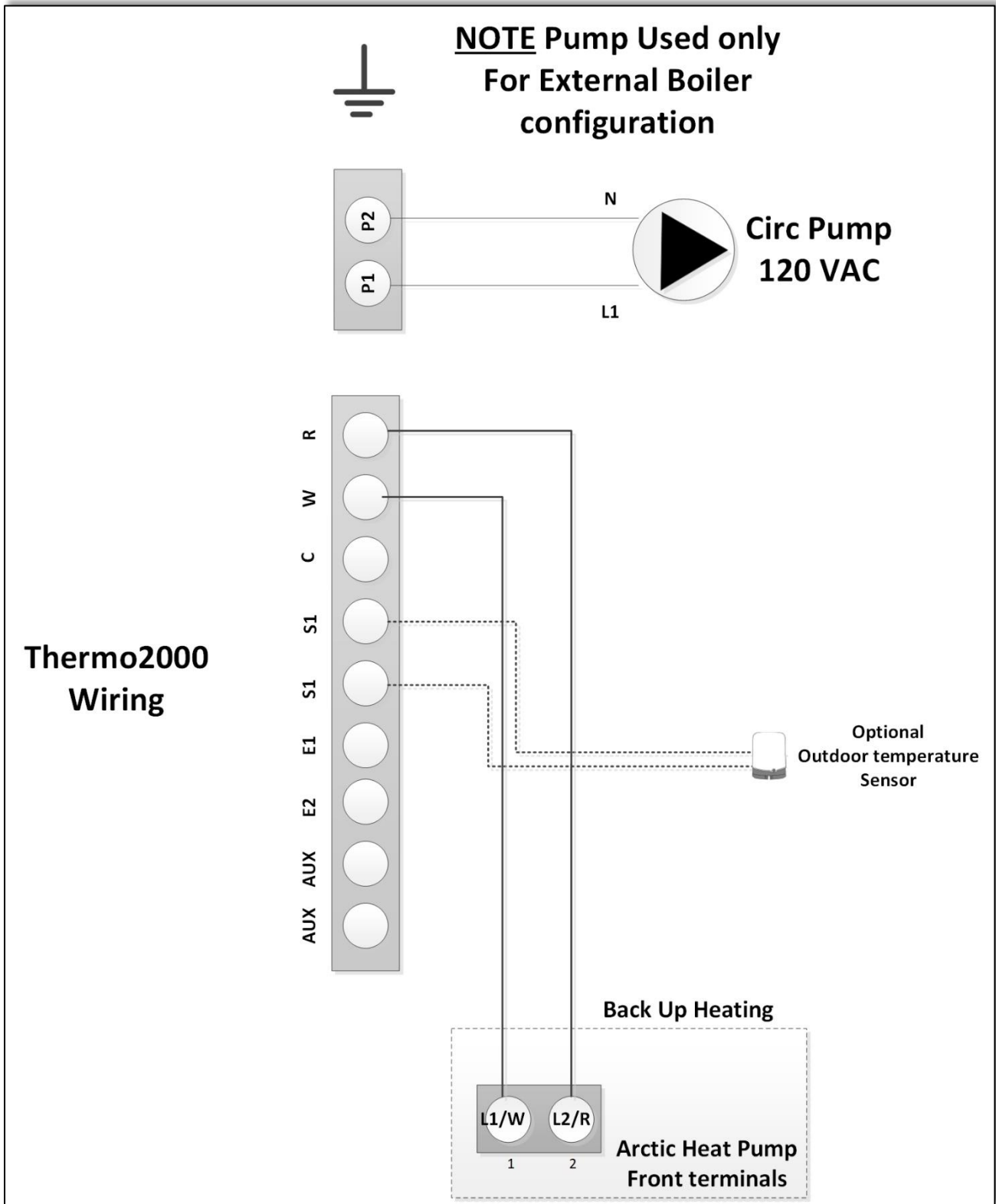

HBX Advanced Back Up ECO-0600



For More back up control we recommend upgrading to a HBX ECO-0600 controller. With this controller users can better control the backup heater of the Arctic Heat Pump based on time delay between stages, outdoor temperature, or differential between setting temp and actual temp. By using an external secondary controller, you can also mitigate the risk that the Heat Pump fails completely and is unable to signal a backup call to the boiler. This could happen in a blown board or blown fuse scenario.

Wiring Diagram- Connect #18 Gauge 2- wire to terminals 7 and 8 on the Eco-0600 controller and W and R on the Boiler.

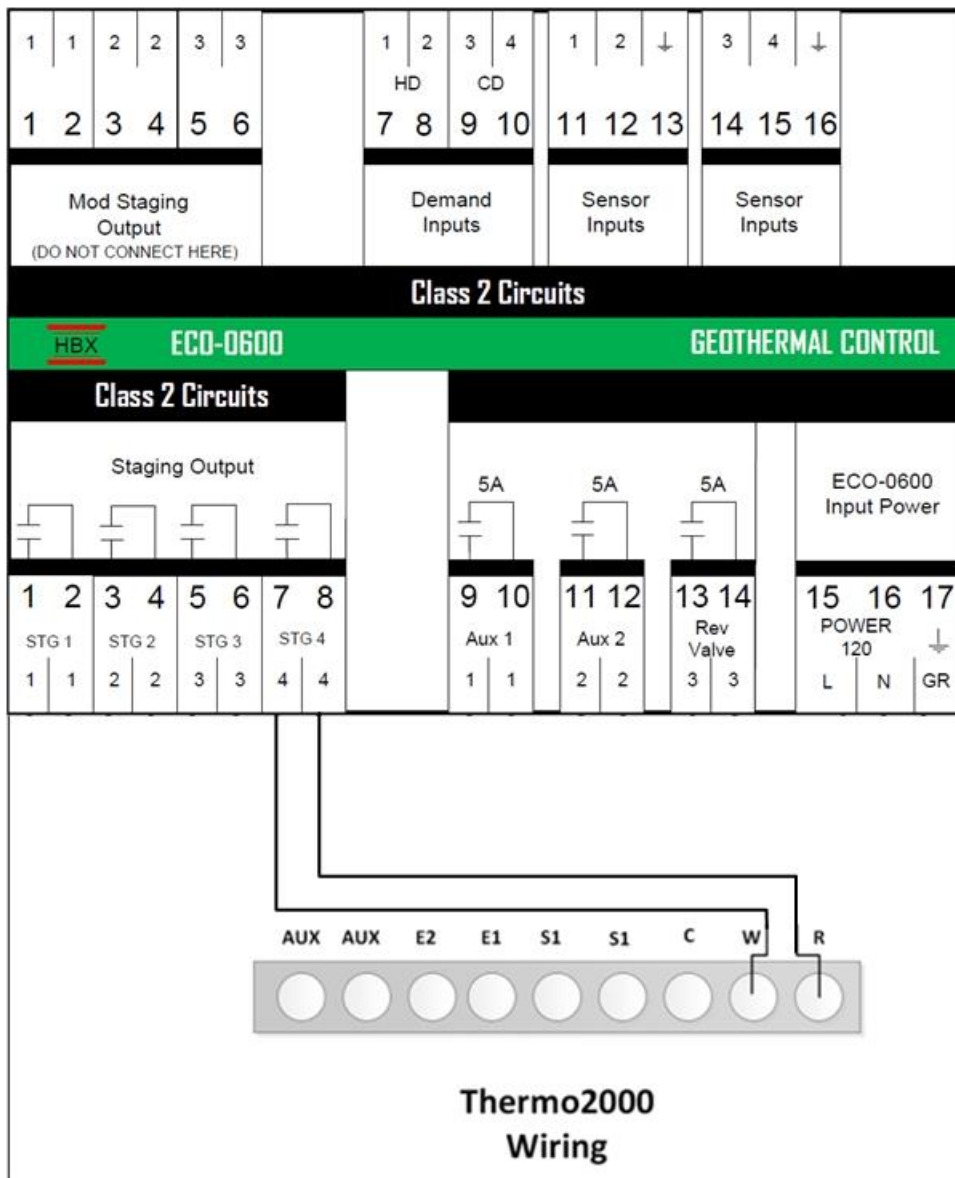

To program the **Back Up** for the heat pump, refer to the ECO-0600 manual to access the advanced programming. The backup setup menu is shown below. Adjust the parameters to allow the backup to run as desired. Commonly backup time is set for 60 minutes to allow the backup to run after an hour of heat pump operation. Also, backup only outdoor should be set for -30°C (-22°F) as this is the low ambient temperature limit for the heat pump to operate in and the backup needs to take over should the outdoor temperature drop this low.



HBX ECO-0600 Geothermal Control
Version 1.0.0

BACKUP SETUP

BACKUP SETUP	
Backup Time	OFF
Backup Temp	OFF
Backup Diff	OFF
Backup Only Outdoor	OFF
Backup Only Tank	OFF

Backup Time - This setting will be set for the minimum lag time between heat pump stages and the backup boiler. This is a time delay between the heat pump stages and the backup boiler. Even if the differential has been exceeded this time must elapse before that stage can come on.
(OFF/1m to 240m) Default: OFF

Backup Temp - Set this temperature to the desired outdoor temperature that will allow the backup to come on. When the outdoor temperature resides above this value, the backup will not be allowed to come on. Only when the Outdoor Temperature falls below this value can the backup come on. This will turn on the Backup for a Hot Tank or DHW call.
(OFF/2°F to 100°F) Default: OFF

Backup Diff - This setting can be used with the backup temperature and backup time or on its own to bring the backup on. This setting is used to set a differential on the tank at which you would like the backup to come on. This setting will override the backup temperature and backup time settings.
(eg. Tank temperature of 115°F and a backup differential of 10°F. The backup boiler will come on at 105°F providing all of the heat pumps are already on.)
(OFF/2°F to 100°F) Default: OFF

Backup Only Outdoor - This option allows you to set a temperature at which the backup will run at all times in favour of the heat pumps, the heat pumps will not run until the outside temperature rises above this setting. This will turn on the Backup for a Hot Tank or DHW call.

Backup Only Tank - Set this to the maximum tank temperature for the heat pumps to run at. Once this temperature has been exceeded, only the backup will heat the tank to the target temperature. To function properly, this temperature should be set lower than the hot tank target temperature. The tank temperature will be based on the Hot Tank during a heat call and the DHW during a DHW call.

Domestic Hot Water

The AltSource tank is equipped with an optional internal Heat Exchanger (HX) for domestic hot water production. This consists of 200 feet of 1/2" copper piping. Based on 120°F water tank temperatures this 200 ft of 1/2" OD cooper pipe, 26.2 sq/ft surface area and has a volume of 1.5 total gallons.

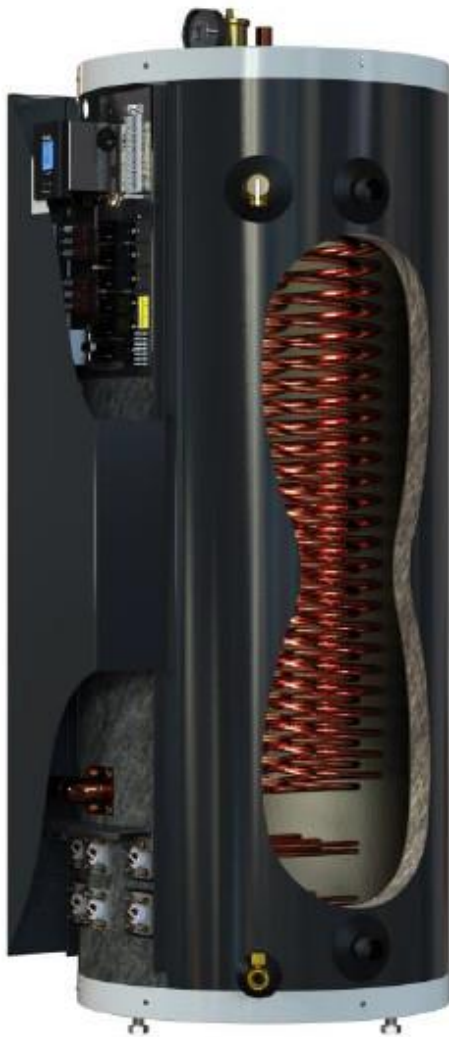

Based on 50°F entering water temp with a tank temp of 120°F the internal HX has a performance variable based on flow rate.

At 2.5usgpm: the DHW outlet temp. shall get to around 115°F.
 At 5.0usgpm: the DHW outlet temp. shall get to around 100°F.

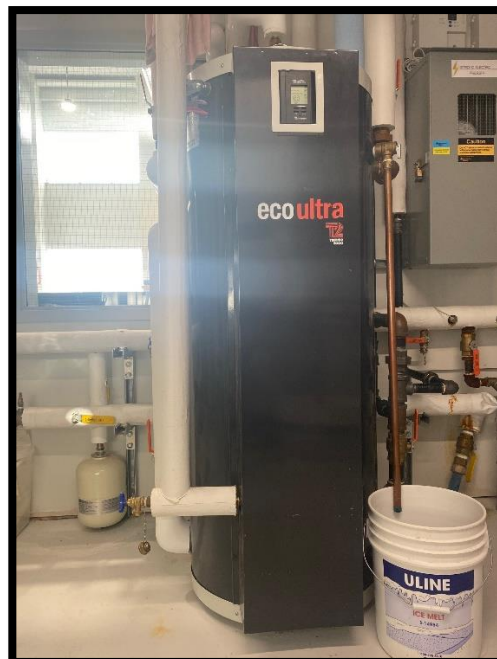
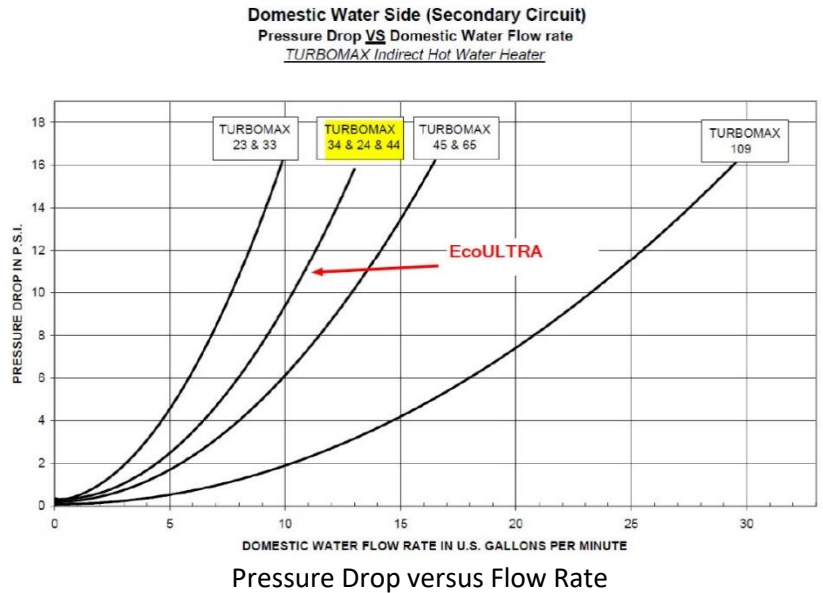

Because the efficiency of the heat pump is better at lower water temperatures, we recommend using the internal domestic hot water coil in a pre-heat arrangement. In this diagram the cold water enters the coil from the bottom and exists at about 95% of the tank setting temperature. Following this the warm water then goes to the primary tank or an on-demand water tank where it is topped up a few degrees to reach 120°F or more depending on the application.

When sizing a heat pump with domestic hot water load please add about 10,000 BTU per person to the daily load. So, a house with 4 people would need an extra 40,000 BTU per day. On an hourly basis this would be 1,667 BTU/hour over 24 hours.

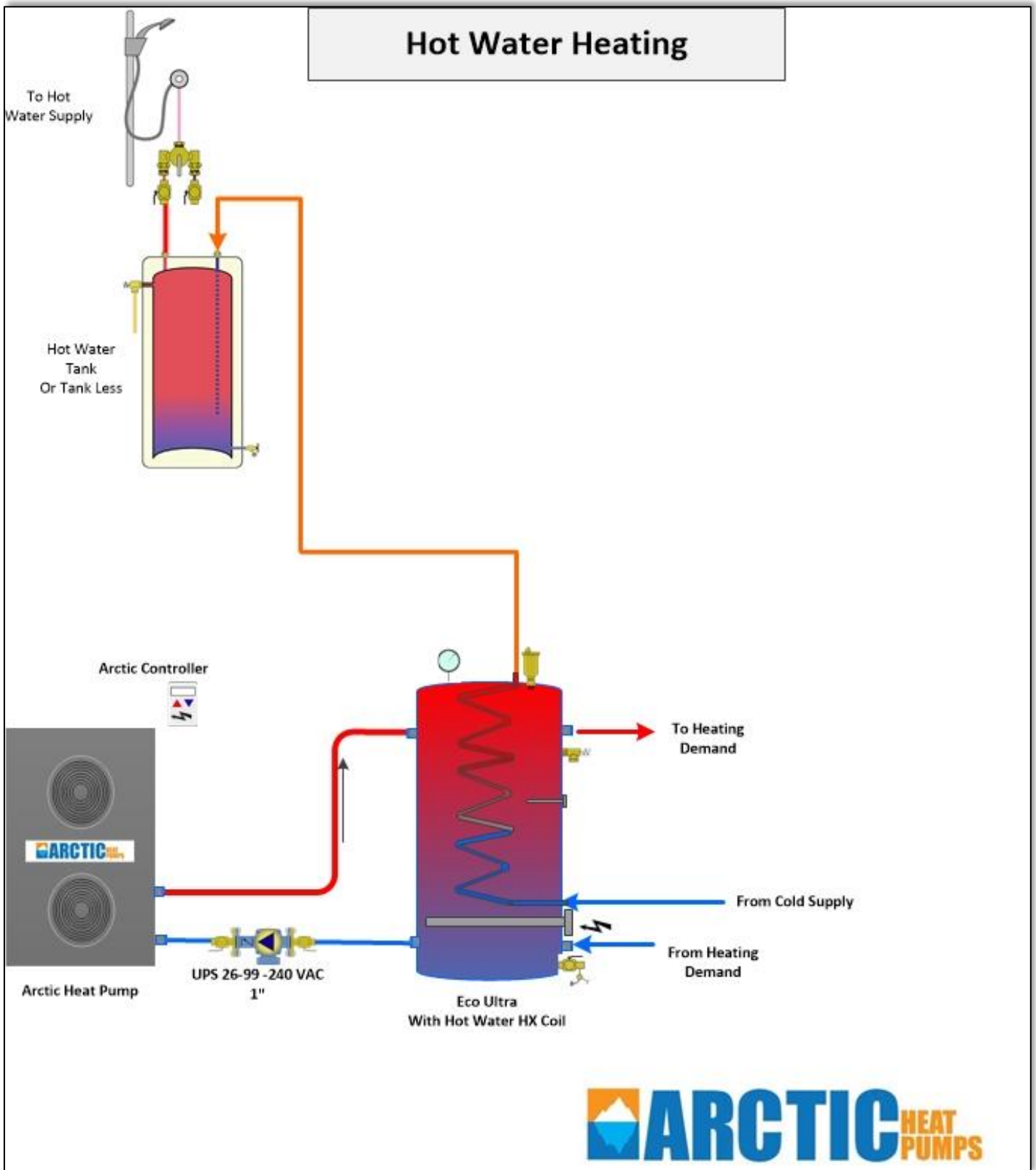

3-Way Valves



The Arctic Heat Pump has a built in 3-Way switching valve that is powered by 240 VAC – only 240 VAC, Normally Open switches should be used. We recommend Belimo or Caleffi 3-way valves with 1" NPT. These valves also come with an internal dry contact switch that is used in most of our cooling layouts to activate an auxiliary source such as a circulation pump. When using a spring-loaded valve such as mentioned above you will only use the S and L2 contacts on the 3-Way Valve terminal block. L1 is reserved for dual motorized switches.

Connect the black wires of the 3-way valve to either terminal on the Arctic Heat Pump. The red wires on the 3-way valve are the internal switch that closes once the 3-way valve is energized and opens.

When installing a 3-way valve pay careful attention to the direction of flow. At the bottom of the valve is the AB connection and is the common flow that both paths take. **B** is the Normally Open (**NO**) path that is opened when no power is supplied to the valve. **A** is the Normally Closed (NC) path and is energized when 240 is supplied to the valve from the heat pump if cooling mode is active on the controller.

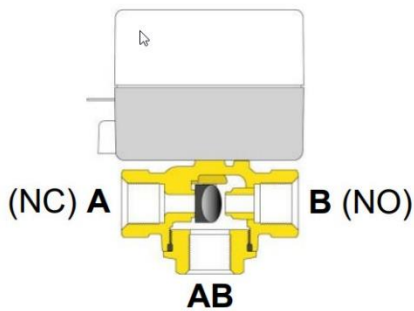

3-way valve with normally closed actuator
(Note: 3-way uses only normally closed actuator)

Wiring Diagram

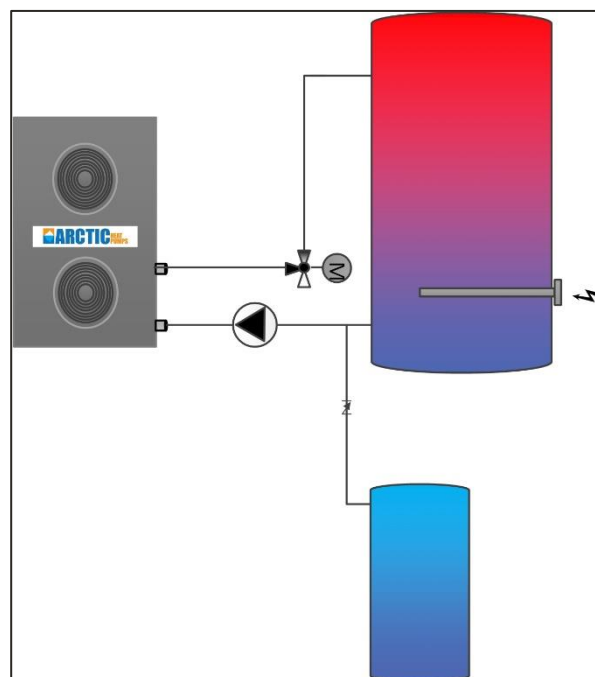
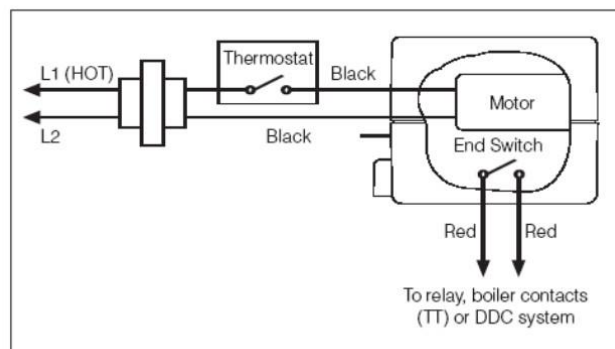

Multiple Heat Pumps

Larger power requirements can be accommodated by adding multiple heat pumps in parallel. When adding multiple units, pipe sizing should be increased at the common home run pipe to accommodate the added flow of more than one pump. For example, if there are three units with 1" piping each. After the header, the piping to the tank should be 1 ¼"-1 ½" (consult a plumber for more technical specifications).

To use multiple heat pumps, we recommend purchase of the HBX advanced ECO-0600 controller. With this controller there are outputs for 4 heat pumps which allow you to load balance and sequence the heat pumps such that they run for the same number of hours on an annual basis. When using a normal controller, staged sequencing will result in the first stage heat pump always running the most hours and the last stage heat pump getting very few hours. The ECO-0600 solves this problem and balances the usage of multiple heat pumps.

When using multiple heat pumps each heat pump is connected to the remote ON/OFF terminal on the heat pump CN36. When the ECO-0600 requires energy from a heat pump it will close the switch and this in turn causes the heat pump to turn on. To have the ECO controller manage the heat pump you should first turn the heat pump's setting to Max and Min values on its controller. This way when the ECO controller has a call the heat pumps will always respond.

HBX ECO-0600 wiring Dual Heat Pump

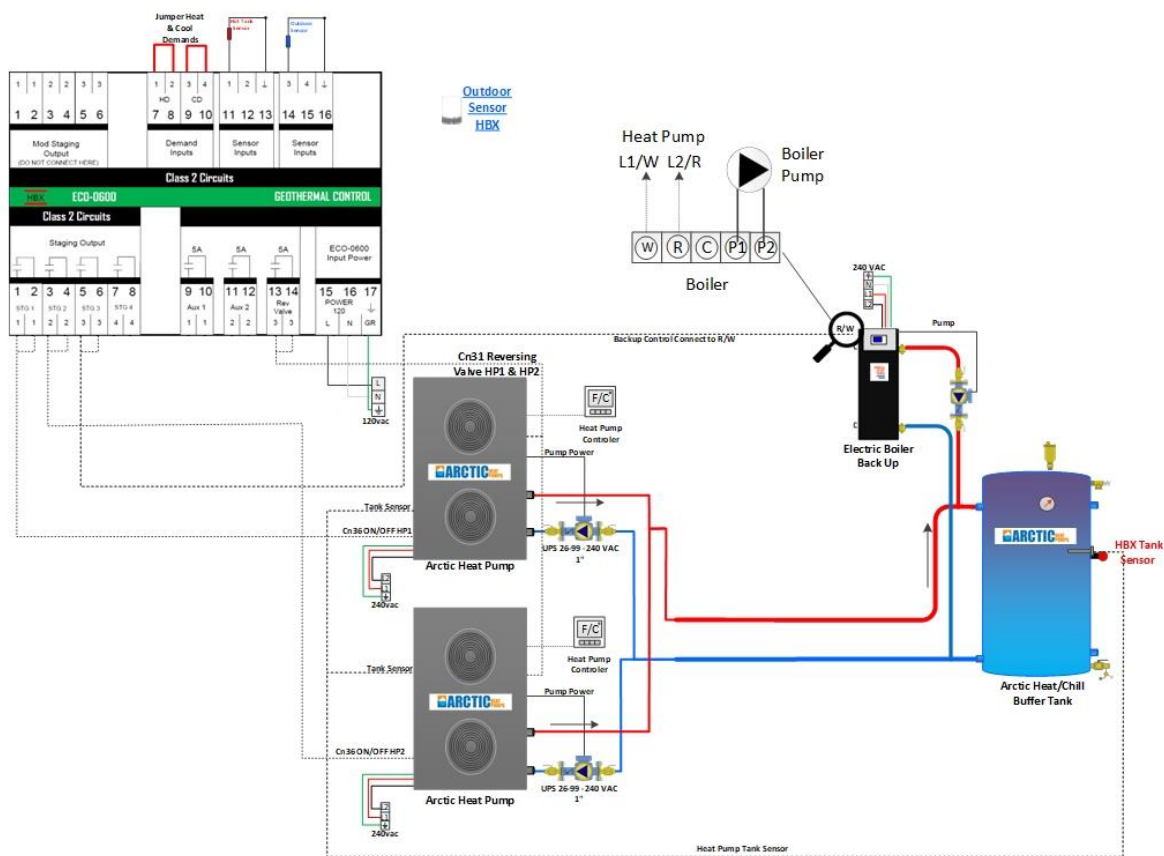

Line Rating
Voltage 120-240
Low Voltage 24 VAC <



To program multiple heat pumps, refer to the ECO-0600 manual to access the advanced programming. Select item #1 and select the options below to sequence the back up. **Note:** if using 4 heat pumps terminals 9 & 10 (AUX 1) can be used for backup.



HBX ECO-0600 Geothermal Control
Version 1.0.0

HEAT PUMP SETUP	
Number of Stages	2
Stage ON Lagtime	0 min
Stage OFF Lagtime	0 sec
Rotate Time	0 hrs
Rotate Cycles	0
Off Staging	OFF

HEAT PUMP SETUP

Number of Stages – This setting will allow you to select the number of heat pump stages that are attached to the control.
 If Backup is being used, you can only have a maximum of 3 stages.
 If Backup is being used with 4 stages of heat pumps then Pump Output 1 will be used for the Backup (1 to 4) Default: 1

Stage ON Lagtime – When the heat pump is set for more than 1 stage, this setting will be set for the minimum lagtime between heat pump stages. This is a time delay between stages. Even if the differential has been exceeded this time must elapse before that stage can come on.
 (1-240 Min)

Stage Off Lagtime – This feature is used to set how you would like to stage the heat pumps off. When the heat pump is set for more than 1 stage, this setting will be set for the minimum OFF lagtime between heat pump stages

Rotate Time – Rotate Time The time of rotation between heat pumps. This setting is in hours of run time. This means that the heat pumps are going to rotate when the first heat pump exceeds the second by the rotate time.
 (OFF/1H to 240H) Default: OFF

Rotate Cycles – Set the number of cycles at which you would like to rotate the heat pumps. One cycle is described as the heat pump going on and then off.
 (OFF/1 to 240) Default: OFF

Off Staging – This feature is used to set how you would like to stage the heat pumps off. If set to OFF the heat pumps will stage off normally based off of tank temperature and differential settings or STAGE OFF Lagtime settings. If set to ON the heat pumps will all stage off at the same time, based off of tank temperature and differential settings.

Heat Pump Reversing Valve Wiring Detail

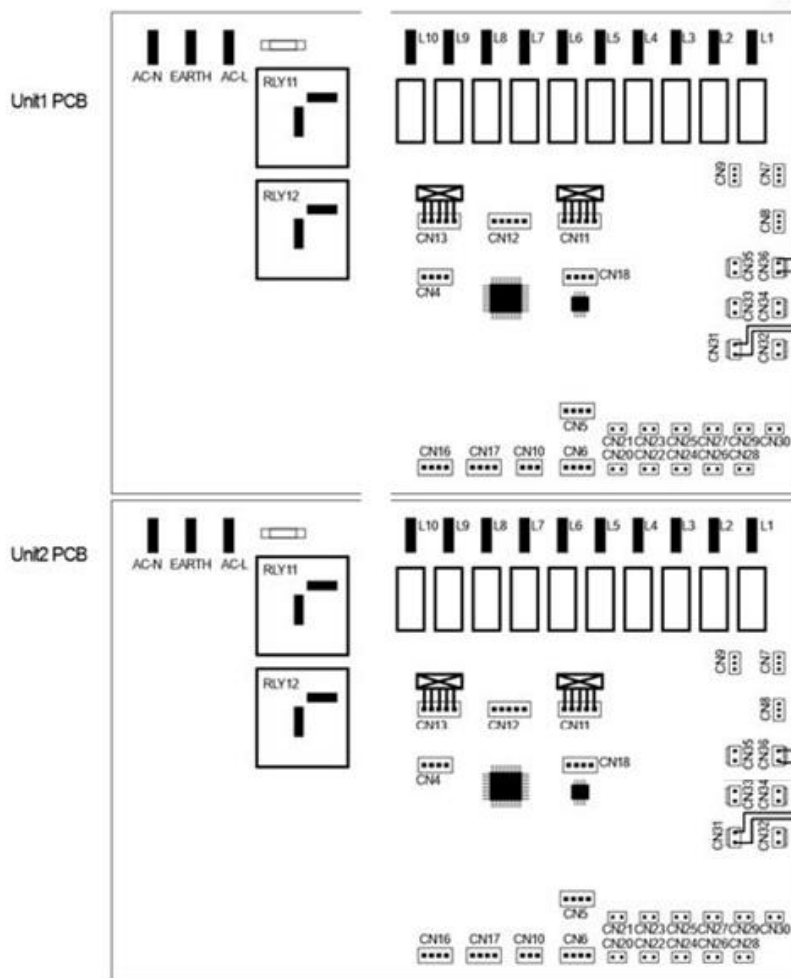
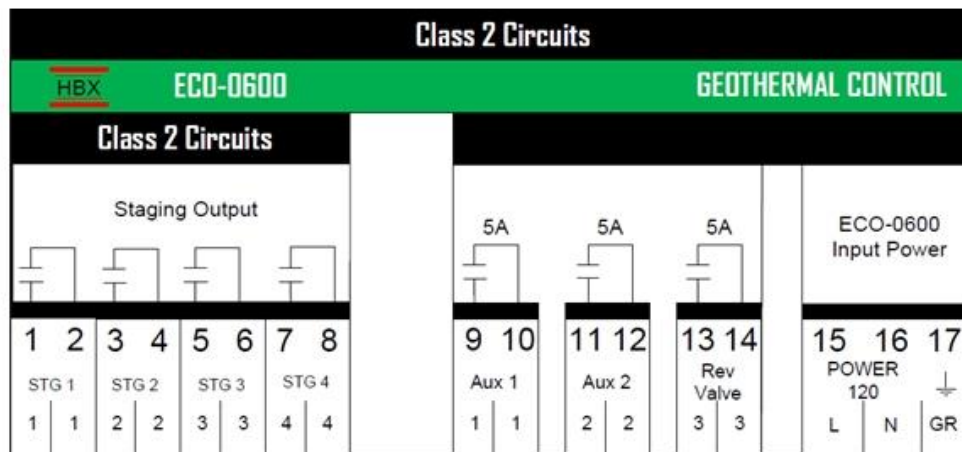

NOTE: Cn31 wiring in series must be exactly as shown with right pin connected to left pin and left to right or closing of the ECO 0550 relay will not be detected.



Flow Valves- It is recommended when running units in parallel that you properly balance the flow so that it is equal in each loop. Remember flow will always take the path of least resistance! You can purchase a Quick Setter Flow meter to balance each loop (see below). Alternatively, you can use the theory of reverse return to ensure each loop has the same amount of supply and return pipe lengths.





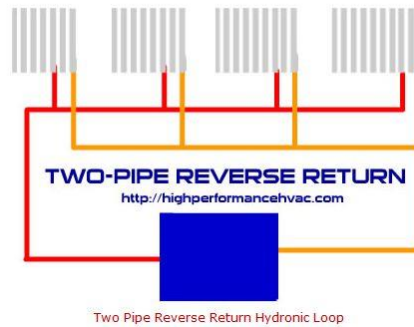

Quick Setter Flow Balancer



Reverse Return Piping

Heating and Cooling - BASIC

The Arctic Heat Pump comes factory set for three options.

1. Heat a Buffer tank 
2. Cool a Buffer tank 
3. Automatic Heat and Cool.  

In the automatic mode it is assumed the owner wants heat in the summer for heating domestic hot water via the AltSource tank and its internal heat exchange coil **AND** wants to cool in Summer. In this hot water takes priority so the hot water setting on the buffer tank needs to be met first before the changeover to cooling will occur. When the unit changes to cooling there is a 3-minute factory delay before this happens. If the hot water tank drops below the set temp, then the unit will change back to heating. In automatic mode there is usually a second tank as the primary tank will be for the domestic hot water and demand heating, and a separate cooling tank is used for cooling. In this case a 3-way valve is used. When in cooling mode the valve will be activated via the 3-way valve terminals L1 and L2 on the heat pump supplying **240vac** to the valve.

Single tank systems are used when there is no domestic hot water in the system. In this case automatic mode is not used and the owner will manually turn the system to cooling in the summer and heating in the winter. To change the mode Press and Hold the Up Arrow button  to cycle through the 3 modes. In a single tank system, there is no need to connect to the 3-way valve terminals. In cooling mode, the 4-way reversing valve internal to the heat pump will change over and the pump will turn on and cycle cold water into the buffer tank.

WARNING: If you are using your Arctic heat pump to provide radiant floor heating, as well as either fan coil or air handler cooling, your radiant floor thermostats must be turned off when you switch the system into cooling mode as condensation may occur if chilled fluid is cycled through the floor without the proper control system.

Heating and Cooling – Advanced

In the basic heating and cooling set up, the target temp for both heating and cooling is set by the customer and the heat pump turns on/off to maintain this temp. This works well but does not utilize the full potential of the heat pump. The set temp points will be used as the maximum water temp and minimum cooling temp needed. However, seldom are these temperatures ever actually needed. They are the MAX needed should it get very cold or very hot outside. Instead by using the Advanced ECO-0600 controller we can set the target temperature based on a sliding curve. As it gets colder out the tank temp will be raised and same with cooling in the summer. This is called “Outdoor Reset.” The heat pump is constantly resetting the target temperature to match the required load based on how cold or hot it is. By doing so we only need to set the water temp to the MAX a couple times during the year. The rest of the time we are saving money by running at a higher COP level (COP goes down as water temp goes up).

HYDRONICS OUTDOOR RESET CONCEPT

FULL RESET OF WATER TEMPERATUR vs. OUTDOOR TEMPERATURE

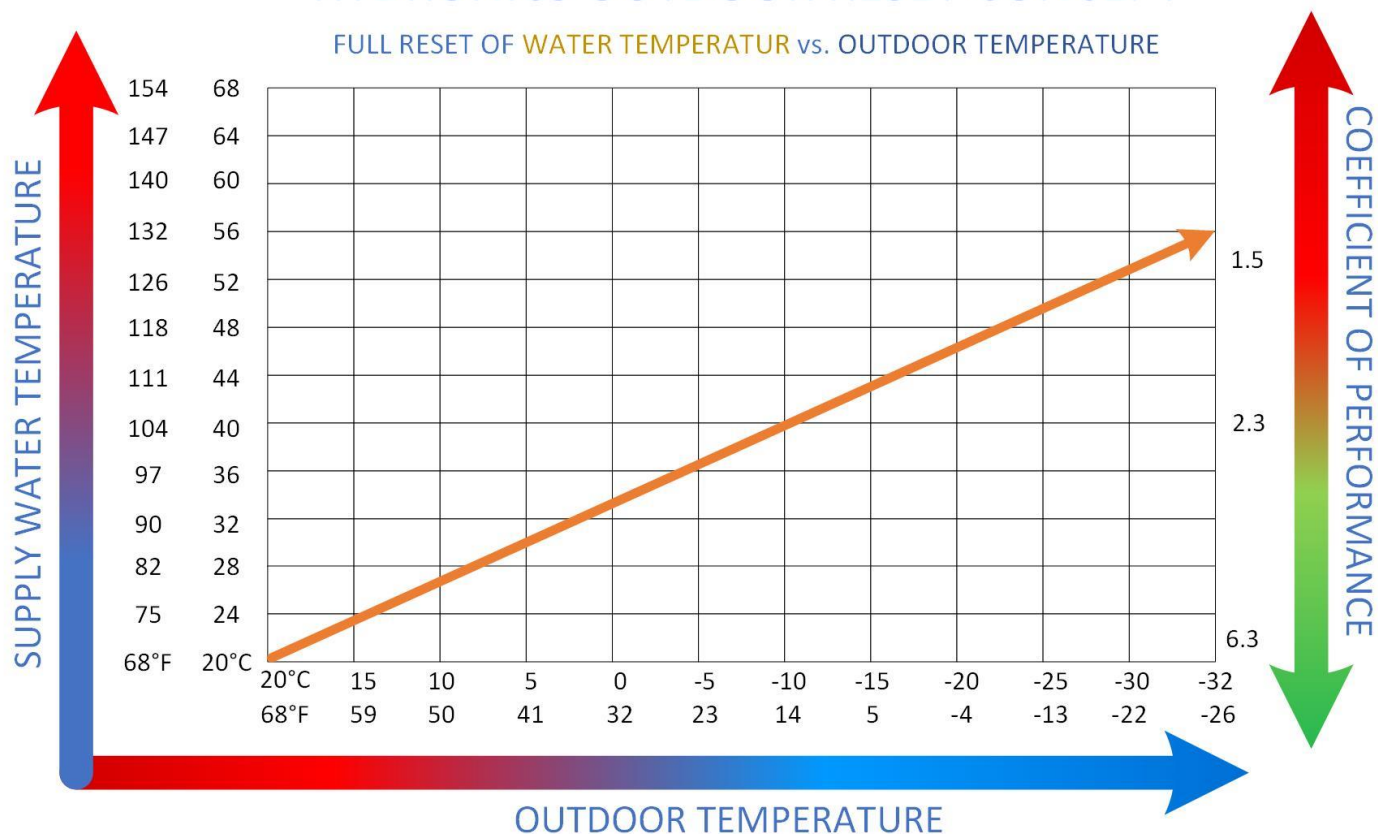

ECO-0600 Heating Cooling Reset



To use the advanced heating and cooling feature of the ECO-0600 you must connect the CN31 terminal to terminals 13 & 14 on the ECO-0600 using #18 gauge 2-wire and the supplied optional terminal pig tail (NOTE by default there is no wire plugged into CN31). The optional pig tail is a separate part that will now be plugged into the Arctic Heat Pump board. When in cooling mode the controller will be closed and CN31 will have a close contact signal. This will cause it to switch to cooling mode. When the controller is open, CN31 will be open and switch to heating mode.

Note: To initialize the Cn31 connection and have the heat pumps mode controlled externally you need to turn on power to the heat pump with the wired controller unplugged. Once you complete this operation the heat pump will forever look to Cn31 for its mode even after a power outage. To cancel the Cn31 connection you need to change advanced parameter 43 from 5-4. This will allow you to now change the mode of the heat pump manually. If you want to re-initialize the Cn31 connection after canceling you will first need to set parameter 43 back to 5 and will then need to power down the heat pump and re-energize it with the wired controller unplugged.

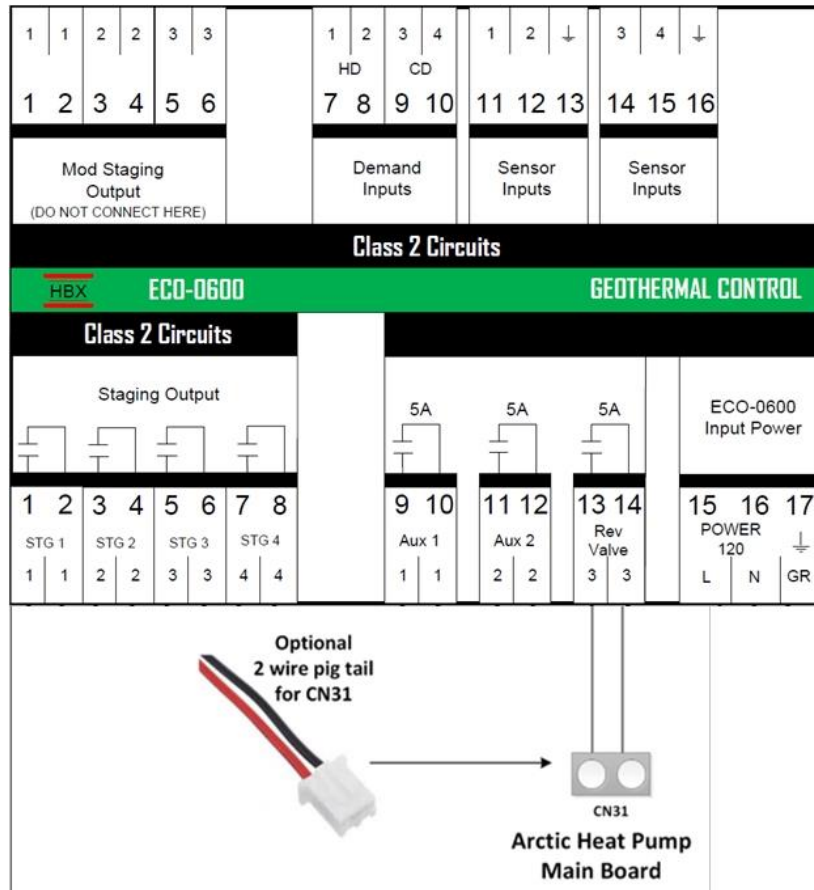

To program multiple heat pumps, refer to the ECO-0600 manual to access the advanced programming.

To program heating and cooling reset, refer to the ECO-0600 manual to access the advanced programming.



HBX ECO-0600 Geothermal Control
Version 1.0.0

TANK SETUP

HOT TANK SETUP	
WWSD	70°
Outdoor Reset	12°
Differential	8°
Max Tank Temp	150°
Min Tank Temp	140°

HOT TANK SETUP WITH OUTDOOR RESET

WWSD - This setting is used to set the temperature in which the ECO-0600 will go into WWSD. If the system rises above this temperature, the system will be shut off. In WWSD the heat pumps and backup boiler will shut off.
(OFF/34°F to 180°F) Default: 65°F

Outdoor Reset (Design) - This is used in the outdoor reset design calculation. This option should be set to reflect your specific city or region. This option needs to be set OFF if you are not using outdoor reset.
*With this option enabled, the Tank Temperature setting will be replaced by Min Tank and Max Tank Temperature settings.
(OFF/-40°F to 127°F) Default: OFF

Differential - Set this temperature to be the desired hot tank differential.
*A differential of 4°F will allow for 2 degrees above and/or 2 degrees below the desired temperature before a demand is present.
(2°F to 100°F) Default: 6°F

Min Tank Temp - This setting is the bottom of the heat curve. The target will hit this temperature as the Outdoor Temperature approaches the WWSD.
(35°F to 200°F) Default: 80°F

Max Tank Temp - This setting is the top of the heat curve. The target will hit this temperature as the Outdoor Temperature approaches the Design Outdoor Temperature.
(35°F to 200°F) Default: 115°F



HBX ECO-0600 Geothermal Control
Version 1.0.0

TANK SETUP

COLD TANK SETUP	
CWSD	70°
Outdoor Reset	12°
Differential	8°
Max Tank Temp	150°
Min Tank Temp	140°

COLD TANK SETUP WITH OUTDOOR RESET

CWSD - This setting is used to set the temperature in which the ECO-0600 will go into CWSD. If the system goes below this temperature, the system will be shut off. In CWSD the heat pumps will shut off.
(OFF/32°F to 119°F) Default: 75°F

Outdoor Reset (Design) - This is used in the outdoor reset design calculation. This option should be set to reflect your specific city or region. This option needs to be setup as OFF if you are not using outdoor reset.
With this option enabled, the Tank Temperature setting will be replaced by Min Tank and Max Tank Temperature settings.
(OFF/0°F to 119°F) Default: OFF

Differential - Set this temperature to be the desired cold tank differential. A differential of 4°F will allow for 2 degrees above and/or 2 degrees below the desired temperature before a demand is present.
(2°F to 100°F) Default: 8°F

Min Tank Temp - This setting is the bottom of the cooling curve. The target will hit this temperature as the outdoor temperature approaches the Outdoor Design Temperature.
(30°F to 200°F) Default: 45°F

Max Tank Temp - This setting is the top of the cooling curve. The target will hit this temperature as the Outdoor Temperature approaches the CWSD.
(30°F to 200°F) Default: 60°F

Limited Warranty

Thank you for purchasing an Arctic Heat Pump. We appreciate your business! We hope your experience with our products meets or exceeds all expectations. Please contact us if you have any issues with, or questions about, your new equipment.

Your Arctic EVI heat pump comes with a **4-year compressor limited warranty**, and a **2-year parts limited warranty**. This warranty protects your equipment against manufacturing or shipping related defects. This warranty will come into effect on the ship date of your equipment. This warranty is only available to the original equipment owner, and only if the product is installed at the original installation site.

This warranty does not cover any component malfunctions deemed to be caused by the incorporation of system design parameters that were not instructed in your equipment manual. This warranty does not cover equipment malfunctions deemed to be caused by the incorporation of third-party components that were not supplied by Arctic. This warranty does not cover component malfunctions deemed to be the result of improper installation practise. Unless your equipment was sized to an Arctic supplied Manual J report, Arctic does not cover system issues resulting from equipment under sizing or over sizing. This warranty does not cover issues resulting from non-adherence to local code. This warranty will be void if product is subject to misuse, improper maintenance, or alteration. This warranty will be void if heat pump is exposed to a corrosive environment.

This limited warranty covers replacement part costs and delivery costs for any component in your heat pump that has been deemed defective. It also covers labor costs required to replace a component at a maximum of \$150 per warranty claim.

Excluded from this warranty is liability for any personal or property damage that resulted from using our products.

Liability is limited and will not exceed cost of pre-approved replacement parts.

Initiate a Warranty Claim

If you believe your Arctic equipment has an issue, contact technical@arcticheatpumps.com or call **1-800-317-9054** and get in touch with Arctic's technical department. An Arctic technician will work with you or your installer to diagnose your system issue. If a component in your heat pump is deemed faulty and eligible for warranty, instructions will be provided to you that detail the process that will be required to remedy your system issue. These instructions will be dependant on your issue.

In the case that a component in your heat pump is faulty and must be replaced, Arctic will ship that component direct and free of charge to a shipping address of your choice as soon as possible. In the shipment of your replacement part their will be a pre-paid return shipping label. That return label is meant for your faulty part. Unless Arctic has instructed not to return faulty part, it is expected that you will package the faulty part and drop it off at the nearest post office as per our technician's instructions.

Our Arctic technicians are in the office from 8:00 AM - 4:30 PM CST Monday to Friday.